

成美号

有限公司



www.goodhandinc.com

2008

CSB SPRING & HARDWARE SDN BHD (766265-X)

No. 154, Jalan Pintal Tali, 10100 Penang.

Tel: 04 263 8975 Tel/Fax: 04 261 1835

Email: csbspring@yahoo.com Website: <http://www.csbspring.com>

產品索引 Product Index

標準零件
備各式材質尺寸和表面處理, 超過 1000 種規格現貨供應

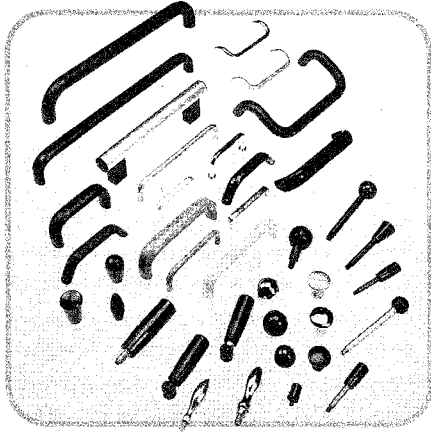

1

一般把手 General Handle

1010 旋轉把手
Revolving Handles P.1



1020 不銹鋼旋轉把手
ST. Steel Revolving Handles P.3



1011 旋轉把手
Revolving Handles P.1



1022 不銹鋼旋轉把手
ST. Steel Revolving Handles P.4



1012 旋轉把手
Revolving Handles P.2



1030 折疊把手
Retractable Handles P.4



1013 旋轉把手
Revolving Handles P.2



1031 折疊把手
Retractable Handles P.5



1014 旋轉把手
Revolving Handles P.3



1040 不銹鋼折疊把手
ST. Steel Retractable Handles P.5



1050 安全把手
Retractable Safety Handles P.6



1060 旋轉式旋鈕
Revolving Ball Knobs P.6



1070 旋轉把手
Revolving Handles P.7



1080 固定式把手
Fixed Handles P.7



1120 球形旋鈕
Ball Knobs P.10



1130 球形旋鈕
Ball Knobs P.11



1140 長珠旋鈕
Cylindrical Knobs P.11



1145 電木橢圓型旋鈕
Bakelite Ellipse Knobs P.12



1090 固定式把手
Fixed Handles P.8



1150 錐形旋鈕
Taper Knobs P.12



1097 固定式把手
Fixed Handles P.8



1151 電木圓錐型旋鈕
Bakelite Taper Knobs P.13



1099 旋轉把手
Revolving Cylindrical Handles P.9



1160 齒輪桿把手
Gear Lever Handles P.14



1100 長珠固定把手
Cylindrical Handles P.9



1170 不銹鋼齒輪桿把手
ST. Steel Gear Lever Handles P.15



1110 球形旋鈕
Ball Knobs P.10



1180 凹槽式旋鈕
Waist Shaped Knobs P.16



1190 香菇型旋鈕
Mushroom Type Knobs P.16



1195 塑膠旋鈕
Plastic Knobs P.17



1196 電木旋鈕
Bakelite Knobs P.17



1197 塑膠旋鈕
Plastic Knobs P.18



1200 U型把手
Cabinet "U" Handles P.18



1201 U型把手
Cabinet "U" Handles P.19



1202 U型把手
Cabinet "U" Handles P.19



1203 U型把手
Cabinet "U" Handles P.20



1204 U型把手
Cabinet "U" Handles P.20



1205 U型把手
Cabinet "U" Handles P.21



1206 U型把手
Cabinet "U" Handles P.21



1210 U型把手
Cabinet "U" Handles P.22



1211 弓型把手
Bow Handles P.22



1212 U型把手
Cabinet "U" Handles P.23



1213 U型把手
Cabinet "U" Handles P.23



1214 不銹鋼U型把手
ST. Steel Cabinet "U" Handles P.24



1215 U型把手
Cabinet "U" Handles P.24



1216 U型把手
Cabinet "U" Handles P.25



1254 U型把手
Cabinet "U" Handles P.25

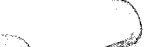

1270 U型把手
Cabinet "U" Handles P.26



1271 U型折疊把手
"U" Collapsible Handles P.26



1280 不銹鋼U型把手
ST. Steel Cabinet "U" Handles P.27



1281 不銹鋼U型折疊把手
ST. Steel "U" Collapsible Handles P.27



1282 不銹鋼拱橋把手
ST. Steel Arch Handles P.28



1290 U型把手
Cabinet "U" Handles P.28



1300 U型把手
Cabinet "U" Handles P.29



1301 不銹鋼U型把手
ST. Steel Cabinet "U" Handles P.29



1322 不銹鋼U型把手
ST. Steel Cabinet "U" Handles P.30



1310 管型把手
Tubular Handles P.30



1311 不銹鋼管型把手
ST. Steel Tubular Handles P.31



1330 管型把手
Tubular Handles P.31

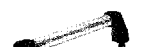

1321 方管型把手
Square Tubular Handles P.32



1400 不銹鋼弧型把手
ST. Steel Arcuate Handles P.32



1401 不銹鋼弧型把手
ST. Steel Arcuate Handles P.33



1402 不銹鋼弧型把手
ST. Steel Arcuate Handles P.33



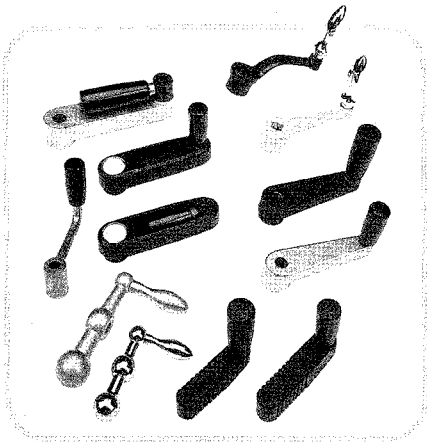

曲柄把手
Cranked Handles
P.39

曲柄把手
Cranked Handles
P.39

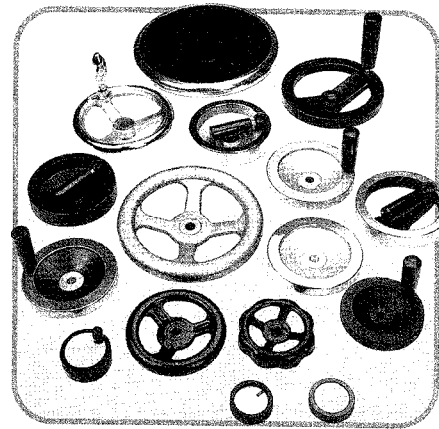

3 手輪把手 Handwheel

3070 塑膠手輪
Plastic Handwheels
P.45

3071 塑膠手輪
Plastic Handwheels
P.45

3072 電木三叉手輪
Bakelite Three-Spoke
Handwheels
P.46

3075 電木三叉手輪
Bakelite Three-Spoke
Handwheels
P.46

3131 碗型手輪
Solid Handwheels
P.49

3150 沖壓成型鋼鐵手輪
Pressed Steel
Handwheels
P.50

3160 沖壓成型不銹鋼手輪
Pressed ST. Steel
Handwheels
P.50

3170 二叉不銹鋼手輪
ST. Steel Offset
Handwheels
P.51

2 搖動把手 Revolving Handle

3016 曲柄把手
Cranked Handles
P.34

3017 曲柄把手
Cranked Handles
P.36

3020 曲柄把手
Cranked Handles
P.34

3021 曲柄把手
Commercial Cranked
Handles
P.37

3026 曲柄把手
Cranked Handles
P.35

3027 三球把手
Tri-Ball Handles
P.37

3030 曲柄把手
Cranked Handles
P.35

3031 曲柄把手
Cranked Handles
P.38

3036 曲柄把手
Cranked Handles
P.36

3037 曲柄把手
Cranked Handles
P.38

3010 手輪
Handwheels
P.40

3015 二叉實心鐵手輪
Two-Spoke Full Cast
Iron Handwheels
P.40

3016 三叉實心鐵手輪
Three-Spoke Full Cast
Iron Handwheels
P.41

3020 碟型手輪
Disc Handwheels
P.41

3030 碟型手輪
Disc Handwheels
P.42

3041 電木碟型手輪
Bakelite Disc
Handwheels
P.42

3050 手輪
Handwheels
P.43

3055 二叉型塑膠手輪
Two-Spoke Plastic
Handwheels
P.43

3056 二叉塑膠手輪
Two-Spoke Plastic
Handwheels
P.44

3061 鋁手輪
Aluminum Handwheels
P.44

3080 控制旋鈕
Control Knobs
P.47

3090 控制旋鈕
Control Knobs
P.47

3100 滾花手輪
Knurled Handwheels
P.48

3120 鋁手輪
Aluminum Handwheels
P.48

3130 碗型鋁手輪
Solid Aluminum
Handwheels
P.49

3160 電木三幅手輪
Bakelite Three Spoked
Handwheels
P.51

3181 電木三幅手輪
Bakelite Three Spoked
Handwheels
P.52

3182 電木三幅手輪
Bakelite Three Spoked
Handwheels
P.52

3190 電木三幅手輪
Bakelite Three Spoked
Handwheels
P.53

3191 電木三幅手輪
Bakelite Three Spoked
Handwheels
P.53

3192

電木三幅手輪
Bakelite Three Spoked
Handwheels P.54



3222

電木碟型手輪
Bakelite Disc
Handwheels P.58



3512

碗型塑膠手輪
Solid Plastic
Handwheels P.63



3200

電木二叉手輪
Bakelite Two Spoked
Handwheels P.54



3230

電木碟型手輪
Bakelite Disc
Handwheels P.59



3520

碗型塑膠手輪
Solid Plastic
Handwheels P.63



3201

電木二叉手輪
Bakelite Two Spoked
Handwheels P.55



3231

電木碟型手輪
Bakelite Disc
Handwheels P.59



3521

碗型塑膠手輪
Solid Plastic
Handwheels P.64



3202

電木二叉手輪
Bakelite Two Spoked
Handwheels P.55



3232

電木碟型手輪
Bakelite Disc
Handwheels P.60



3522

碗型塑膠手輪
Solid Plastic
Handwheels P.64



3210

電木二叉手輪
Bakelite Two Spoked
Handwheels P.56



3500

碗型塑膠手輪
Solid Plastic
Handwheels P.60



3211

電木二叉手輪
Bakelite Two Spoked
Handwheels P.56



3501

碗型塑膠手輪
Solid Plastic
Handwheels P.61



3212

電木二叉手輪
Bakelite Two Spoked
Handwheels P.57



3502

碗型塑膠手輪
Solid Plastic
Handwheels P.61



3220

電木碟型手輪
Bakelite Disc
Handwheels P.57



3510

碗型塑膠手輪
Solid Plastic
Handwheels P.62



3221

電木碟型手輪
Bakelite Disc
Handwheels P.58



3511

碗型塑膠手輪
Solid Plastic
Handwheels P.62

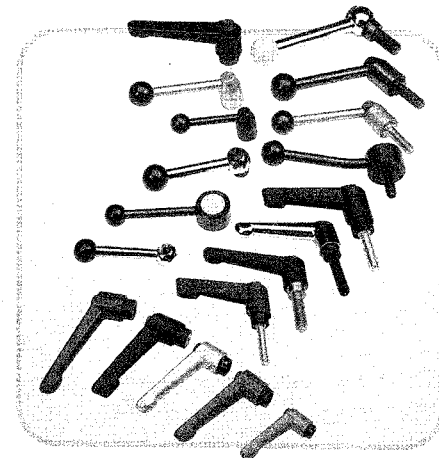

4 可調式把手 Adjustable Handle

NEW

不銹鋼可調式把手
ST. Steel Adjustable
Hand Levers P.70



NEW

平頭萬向把手
Flat Adjustable
Tension Levers P.74



NEW

不銹鋼可調式把手
ST. Steel Adjustable
Hand Levers P.70



NEW

不銹鋼可調式把手
ST. Steel Adjustable
Hand Levers P.71



NEW

不銹鋼可調式把手
ST. Steel Adjustable
Hand Levers P.71



4010

可調式把手
Adjustable Hand Levers P.65



4015

可調式把手
Adjustable Hand Levers P.67



4070

萬向把手
Adjustable Tension
Levers P.72



4020

可調式把手
Adjustable Hand Levers P.65



4025

可調式把手
Adjustable Hand Levers P.68



4080

萬向把手
Adjustable Tension
Levers P.72

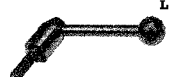

4030

可調式把手
Adjustable Hand Levers P.66



NEW

4040

可調式把手
Adjustable Hand Levers P.68



4090

不銹鋼萬向把手
ST. Steel Adjustable
Hand Levers P.73



4031

可調式把手
Adjustable Hand Levers P.66



4050

不銹鋼可調式把手
ST. Steel Adjustable
Hand Levers P.69



4100

不銹鋼萬向把手
ST. Steel Adjustable
Hand Levers P.73



NEW

可調式把手
Adjustable Hand Levers P.67



NEW

4055

不銹鋼可調式把手
ST. Steel Adjustable
Hand Levers P.69



4150

平頭萬向把手
Flat Adjustable
Tension Levers P.74

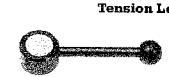

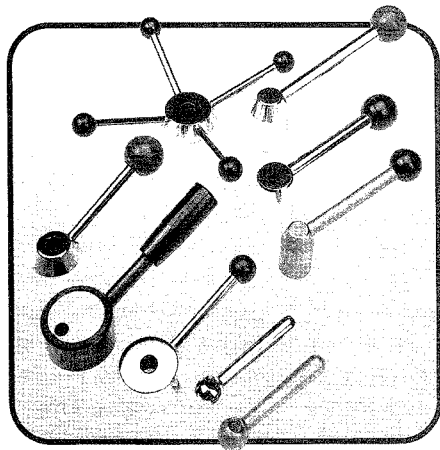





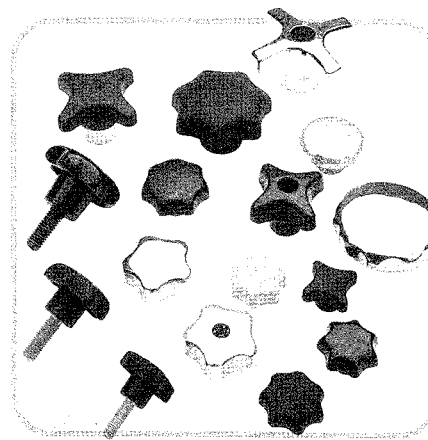



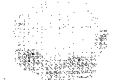











5 夾持拉桿 Clamping Lever

- | | |
|---|---|
| <p>5010 雜柱把手
Clamping Levers
P.75</p>  | <p>5060 砲塔式把手
Turret Levers
P.77</p>  |
| <p>5020 煙斗把手
Tension Levers
P.75</p>  | <p>5065 電木雙桿砲塔式把手
Bakelite Two Arms
Turret Levers
P.78</p>  |
| <p>5030 控制把手
Control Levers
P.76</p>  | <p>5070 把手調整座
Split Hubs
P.78</p>  |
| <p>5035 控制把手
Control Levers
P.76</p>  | |
| <p>5051 控制把手
Control Levers
P.77</p>  | |

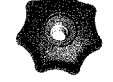

6 星型旋鈕 Hand Knob

- | | | | |
|--|--|--|---|
| <p>5040 星型旋鈕
Hand Knobs
P.79</p>  | <p>5080 星型旋鈕
Hand Knobs
P.81</p>  | <p>5100 十字型旋鈕
Star Knobs
P.86</p>  | <p>5221 塑膠星型旋鈕
Plastic Hand Knobs
P.90</p>  |
| <p>5071 星型旋鈕
Hand Knobs
P.79</p>  | <p>5090 星型旋鈕
Hand Knobs
P.82</p>  | <p>5110 十字型旋鈕
Star Knobs
P.86</p>  | <p>5222 塑膠星型旋鈕
Plastic Hand Knobs
P.91</p>  |
| <p>5072 星型旋鈕
Hand Knobs
P.80</p>  | <p>5090 不銹鋼星型旋鈕
ST. Steel Hand Knobs
P.82</p>  | <p>5120 不銹鋼星型旋鈕
ST. Steel Hand Knobs
P.87</p>  | <p>5223 塑膠星型旋鈕
Plastic Hand Knobs
P.91</p>  |
| <p>5090 星型旋鈕
Hand Knobs
P.80</p>  | <p>5095 不銹鋼星型旋鈕
ST. Steel Hand Knobs
P.83</p>  | <p>5130 星型旋鈕
Hand Knobs
P.87</p>  | <p>5224 塑膠星型旋鈕
Plastic Hand Knobs
P.92</p>  |
| <p>5095 穿孔星型旋鈕
Penetrated Hand Knobs
P.81</p>  | <p>5090 星型旋鈕
Hand Knobs
P.83</p>  | <p>5225 電木星型旋鈕
Bakelite Hand Knobs
P.88</p>  | <p>5225 塑膠星型旋鈕
Plastic Hand Knobs
P.92</p>  |

- | | |
|---|---|
| <p>5050 不銹鋼星型旋鈕
ST. Steel Hand Knobs
P.84</p>  | <p>5218 電木星型旋鈕
Bakelite Hand Knobs
P.88</p>  |
| <p>5055 星型快速釋放
Quick Release
Hand Knobs
P.84</p>  | <p>5219 電木穿孔星型旋鈕
Bakelite Penetrated
Hand Knobs
P.89</p>  |
| <p>5060 十字型旋鈕
Star Knobs
P.85</p>  | <p>5220 電木穿孔星型旋鈕
Bakelite Penetrated
Hand Knobs
P.89</p>  |
| <p>5080 十字型旋鈕
Star Knobs
P.85</p>  | <p>5224 塑膠星型旋鈕
Plastic Hand Knobs
P.90</p>  |

6286 塑膠三幅旋鈕
Plastic Three Lobe Knobs
P.93



6320 塑膠三角型旋鈕
Plastic Three Lobe Knobs
P.97



6300 電木星型旋鈕
Bakelite Hand Knobs
P.102



6287 塑膠三幅旋鈕
Plastic Three Lobe Knobs
P.93



6336 塑膠三角型旋鈕
Plastic Three Lobe Knobs
P.98



6330 電木星型旋鈕
Bakelite Hand Knobs
P.102



6270 塑膠三幅旋鈕
Plastic Three Lobe Knobs
P.94



6338 電木星型旋鈕
Bakelite Hand Knobs
P.98



6280 塑膠旋鈕
Plastic Knobs
P.94



6341 電木星型旋鈕
Bakelite Hand Knobs
P.99



6290 塑膠旋鈕
Plastic Knobs
P.95



6350 電木星型旋鈕
Bakelite Hand Knobs
P.99



6304 電木三角型旋鈕
Bakelite Three Lobe Knobs
P.95



6360 電木星型旋鈕
Bakelite Hand Knobs
P.100



6310 電木三角型旋鈕
Bakelite Three Lobe Knobs
P.96



6361 電木星型旋鈕
Bakelite Hand Knobs
P.100



6320 塑膠三角型旋鈕
Plastic Three Lobe Knobs
P.96



6370 電木星型旋鈕
Bakelite Hand Knobs
P.101



6321 塑膠三角型旋鈕
Plastic Three Lobe Knobs
P.97



6376 電木星型旋鈕
Bakelite Hand Knobs
P.101

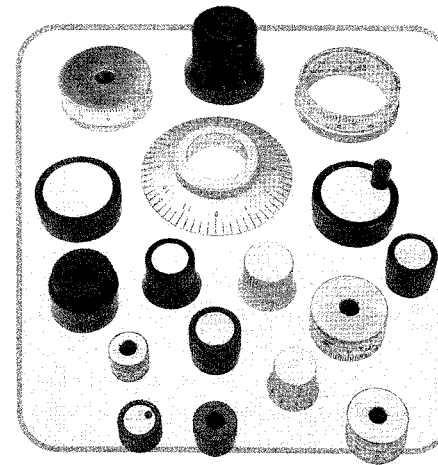

7 刻度環 Control Knob

7010 刻度環
Scale Rings
P.103

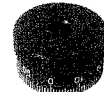

7011 刻度環
Scale Rings
P.103



7020 控制旋鈕
Control Knobs
P.104



7030 控制旋鈕
Control Knobs
P.104



7040 控制旋鈕
Control Knobs
P.105



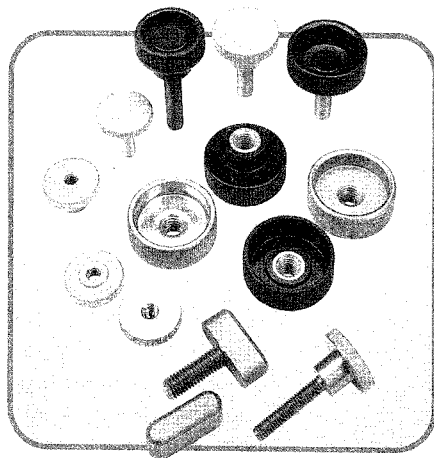

8 壓花螺絲螺帽 Knurled Nut

8010 壓花螺絲
Knurled Thumb Screws
P.106



8050 不銹鋼圓頭螺絲
ST. Steel Wing Screws
P.108

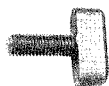

8020 不銹鋼壓花螺絲
ST. Steel Knurled Thumb
Screws
P.106



8060 不銹鋼圓頭螺帽
ST. Steel Wing Nuts
P.109



8030 通孔壓花螺帽
Penetrated Knurled Nuts
P.107



8061 一字旋鈕螺絲
Wing Knob Screws
P.109



8031 壓花螺帽
Knurled Nuts
P.107



8062 一字旋鈕螺帽
Wing Knob Nuts
P.110



8040 不銹鋼壓花螺帽
ST. Steel Knurled Nuts
P.108



8070 平頭壓花螺絲
Flat Knurled Thumb
Screws
P.110



8080 平頭壓花螺帽
Flat Knurled Nuts
P.111



8090 凸型壓花螺絲
Knurled Thumb Screws
P.111



8100 不銹鋼凸型壓花螺絲
ST. Steel Knurled
Thumb Screws
P.112

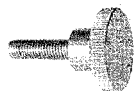

8110 壓花螺帽
Knurled Nuts
P.112

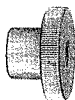

8120 不銹鋼壓花螺帽
ST. Steel Knurled Nuts
P.113



8130 壓花螺帽
Knurled Nuts
P.113



8140 不銹鋼壓花螺帽
ST. Steel Knurled Nuts
P.114

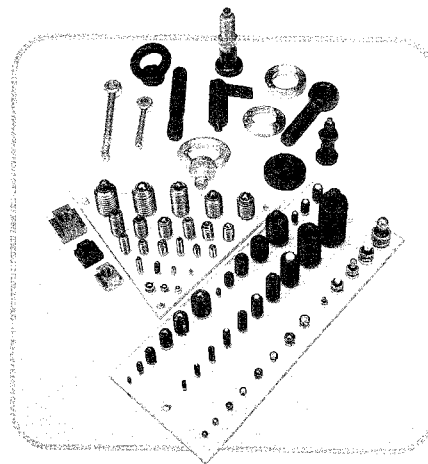

9 夾持零配件 Clamping Accessories

8015 定位柱
Indexing Plungers
P.115



8057 等高螺絲
Contour Screws
P.117



8025 定位柱
Cam Action Indexing Plungers
P.115



8059 支撐座
Thrust Pads
P.118



8035 不銹鋼定位珠
ST. Steel Spring Plungers
P.116



8075 搖擺螺絲
Swing Bolts
P.118



8045 定位珠
Spring Plungers
P.116



8071 不銹鋼搖擺螺絲
ST. Steel Swing Bolts
P.119



8055 可動聯結螺絲
Grab Screws
P.117



8080 T型螺帽
T-Nuts
P.119

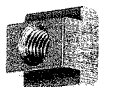

8017 凸緣螺帽
Collar Nuts
P.120

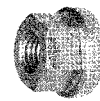

8170 機械吊鉤
Machinery Hooks
P.124



8095 沉頭孔墊片
Countersunk Washers
P.120



8175 平放腳
Knuckle Joints
P.125



8096 公件球型華司
Male Spherical Washers
P.121



8180 標準型水平調整座
Standard Type
Adjustable Seats
P.126



8098 母件圓錐型座
Female Spherical
Washers
P.121



8190 防震型水平調整座
Shockproof Type
Adjustable Seats
P.126



8106 吊環
Lifting Eye Bolts
P.122



8195 防震腳座
Aseismatic Seats
P.127



8116 不銹鋼吊環
ST. Steel Lifting
Eye Bolts
P.122



8200 精密腳座
Detailed Seats
P.127



8117 吊環
Lifting Eye Bolts
P.123



8205 防震腳座
Aseismatic Seats
P.128



8118 不銹鋼吊環
ST. Steel Lifting
Eye Bolts
P.123



8207 多功能防震腳座
Multi-function
Detailed Seats
P.128



8119 吊環柱
Hook Screws
P.124



**ZIMMERMANN
PRODUCTS**
P.131 - P.139

旋轉把手 Revolving Handles

1010

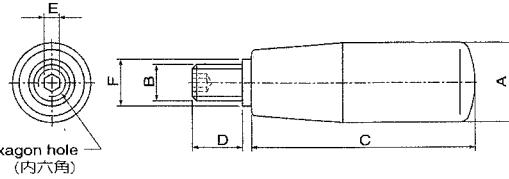

名稱 Name	材質 Material	表面處理 Surfaced process
把手 Handle	電木 Bakelite (KU)	黑色 Black
軸 Spindle	鋼鐵 Steel (ST)	鍍鋅 Zincing (ZI)

(mm)

Order No. 電木 (KU)	A	B	C	D	E	F
1010 - 14 - M 6	14	M6	28	10	3	8
- 18 - M 6	18	M6	40	12	3	10
- 21 - M 6	21	M6	50	13	3	10
- 21 - M 8	21	M8	50	13	4	10
- 23 - M 8	23	M8	65	14	4	13
- 23 - M10	23	M10	65	14	5	13
- 26 - M 8	26	M8	80	16	4	13
- 26 - M10	26	M10	80	16	5	13
- 28 - M10	28	M10	90	16	5	13
- 31 - M12	31	M12	102	20	6	14

旋轉把手 Revolving Handles

1012

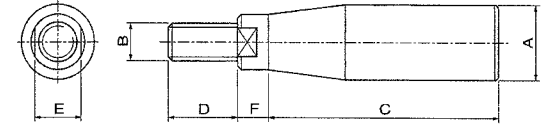
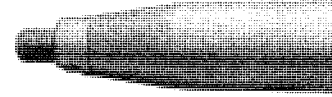

名稱 Name	材質 Material	表面處理 Surfaced process
把手 Handle	鋼鐵 Steel (ST)	鍍亮鉻 Chrome bright (CR)
軸 Spindle	鋼鐵 Steel (ST)	鍍霧銀 Matt silver (EL)

(mm)

Order No. 鋼鐵 (ST)	A	B	C	D	E	F
1012 - 16 - M 6	16	M6	58	13	10	9
- 16 - M 8	16	M8	58	13	10	9
- 20 - M 8	20	M8	58	13	10	9
- 22 - M10	22	M10	70	14	14	10
- 25 - M12	25	M12	84	20	17	13

旋轉把手 Revolving Handles

1011

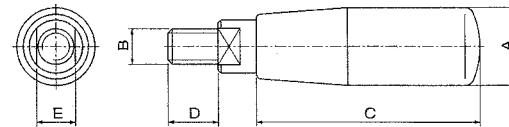

名稱 Name	材質 Material	表面處理 Surfaced process
把手 Handle	電木 Bakelite (KU)	黑色 Black
軸 Spindle	鋼鐵 Steel (ST)	鍍鋅 Zincing (ZI)

(mm)

Order No. 電木 (KU)	A	B	C	D	E
1011 - 21 - M 6	21	M6	50	13	8
- 21 - M 8	21	M8	50	13	8
- 23 - M 8	23	M8	65	14	10
- 23 - M10	23	M10	65	14	10
- 26 - M 8	26	M8	80	16	10
- 26 - M10	26	M10	80	16	10
- 28 - M10	28	M10	90	16	10

[1]

旋轉把手 Revolving Handles

1013

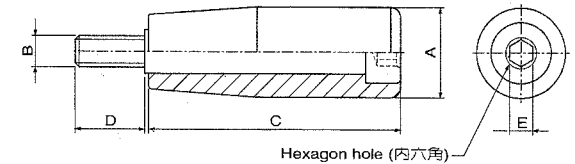

名稱 Name	材質 Material
把手 Handle	尼龍加玻璃纖維 (KT)
軸 Spindle	鋼鐵 Steel (ST)

(mm)

Order No. 尼龍加玻璃纖維 (KT)	A	B	C	D	E
1013 - 14 - M 6	14	M6	20	10	-
- 21 - M 6	21	M6	50	13	5
- 21 - M 8	21	M8	50	13	5
- 23 - M 8	23	M8	65	14	6
- 23 - M10	23	M10	65	14	6
- 26 - M 8	26	M8	79	16	6
- 26 - M10	26	M10	79	16	6

[2]

旋轉把手 Revolving Handles

1014

NEW

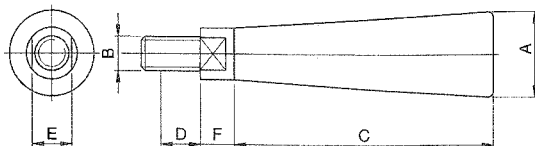

名稱 Name	材質 Material	表面處理 Surface process
旋鈕 Knob	塑膠 Plastic (KT)	黑色 Black
軸 Spindle	鋼鐵 Steel (ST)	

(mm)

Order No. 塑膠 (KT)	A	B	C	D	E	F
1014 - 16 - M 6	16	M6	43	13	8	7
- 20 - M 8	20	M8	55	17	10	8
- 25 - M10	25	M10	70	20	14	10
- 31 - M12	31	M12	88	20	17	13

不銹鋼旋轉把手 ST. Steel Revolving Handles

1020

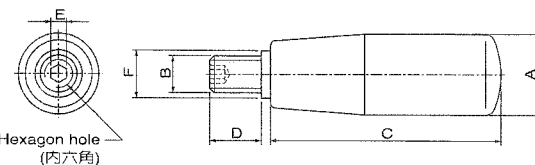

名稱 Name	材質 Material	表面處理 Surface process
把手 Handle	電木 Bakelite (KU)	黑色 Black
軸 Spindle	不銹鋼 Stainless steel (SST)	

(mm)

Order No. 電木 (KU)	A	B	C	D	E	F
1020 - 14 - M 6	14	M6	28	10	3	8
- 18 - M 6	18	M6	40	12	3	10
- 21 - M 6	21	M6	50	13	3	10
- 21 - M 8	21	M8	50	13	4	10
- 23 - M 8	23	M8	65	14	4	13
- 23 - M10	23	M10	65	14	5	13
- 26 - M 8	26	M8	80	16	4	13
- 26 - M10	26	M10	80	16	5	13
- 28 - M10	28	M10	90	16	5	13
- 31 - M12	31	M12	102	20	5	14

[3]

不銹鋼旋轉把手 ST. Steel Revolving Handles

1022

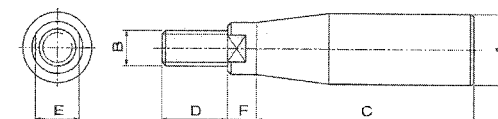

名稱 Name	材質 Material
把手 Handle	不銹鋼 Stainless steel (SST)
軸 Spindle	不銹鋼 Stainless steel (SST)

(mm)

Order No. 不銹鋼 (SST)	A	B	C	D	E	F
1022 - 16 - M 6	16	M6	60	13	10	9
- 16 - M 8	16	M8	60	13	10	9
- 20 - M 8	20	M8	60	13	10	9
- 22 - M10	22	M10	70	14	14	10
- 25 - M12	25	M12	94	20	17	13
- 28 - M16	28	M16	106	22	19	14

折疊把手 Retractable Handles

1030

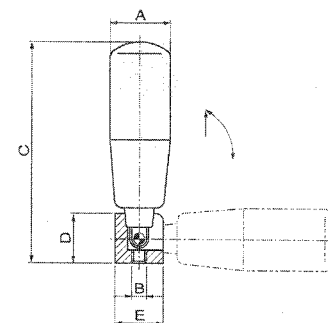

名稱 Name	材質 Material	表面處理 Surface process
把手 Handle	電木 Bakelite (KU)	黑色 Black
折疊結構 Retractable Mechanism	鋼鐵 Steel (ST)	電鍍黑色 Matt black (B)

(mm)

Order No. 電木 (KU)	A	B	C	D	E
1030 - 18 - M5	18	M5	57	15	16
- 21 - M5	21	M5	67	15	16
- 23 - M6	23	M6	87	19.5	20
- 26 - M6	26	M6	102	19.5	20
- 28 - M8	28	M8	118	26	26
- 31 - M8	31	M8	128	26	26

[4]

折疊把手 Retractable Handles

1031

NEW

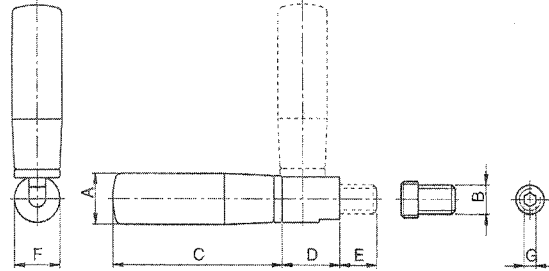
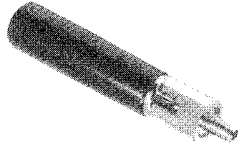

名稱 Name	材質 Material	表面處理 Surfaced process
把手 Handle	塑膠 Plastic (KT)	黑色 Black
折疊結構 Retractable Mechanism	鋼鐵 Steel (ST)	鍍鋅 Zincing (Z)

(mm)

Order No. (訂號)	A	B	C	D	E	F	G
1031-18-M5	18	M5	50	21	13	16	4
-22-M5	22	M5	71	22.5	14	20	4
-22-M10	22	M10	77	22.5	15	20	5
26-M12	26	M12	85	24	21	22	5

不銹鋼折疊把手 ST. Steel Retractable Handles

1040

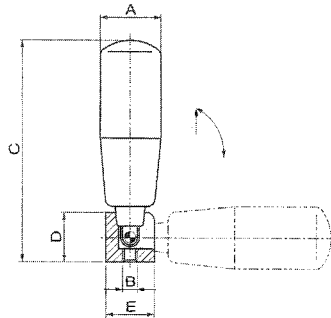
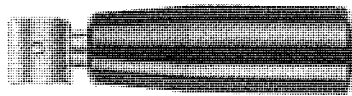

名稱 Name	材質 Material	表面處理 Surfaced process
把手 Handle	電木 Bakelite (KU)	黑色 Black
折疊結構 Retractable Mechanism	不銹鋼 Stainless steel (SST)	

(mm)

Order No. 電木 (KU)	A	B	C	D	E
1040-18-M5	18	M5	57	15	16
-21-M5	21	M5	67	15	16
-23-M6	23	M6	87	19.5	20
-26-M6	26	M6	102	19.5	20
-28-M8	28	M8	118	26	26
-31-M8	31	M8	128	26	26

[5]

安全把手 Retractable Safety Handles

1050

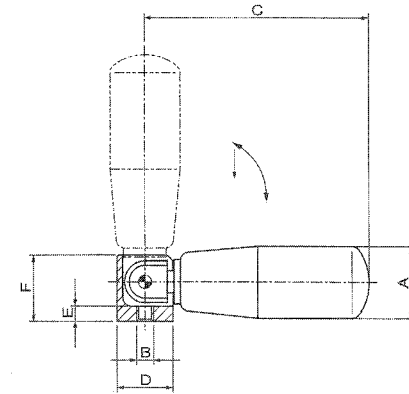

名稱 Name	材質 Material	表面處理 Surfaced process
把手 Handle	電木 Bakelite (KU)	黑色 Black
折疊結構 Retractable Mechanism	鋼鐵 Steel (ST)	電鍍黑色 Matt black (B)

(mm)

Order No. (訂號)	A	B	C	D	E	F
1050-23-M6	23	M6	77	20	5.5	22
-24-M8	24	M8	82	20	5.5	22

旋轉式旋鈕 Revolving Ball Knobs

1060

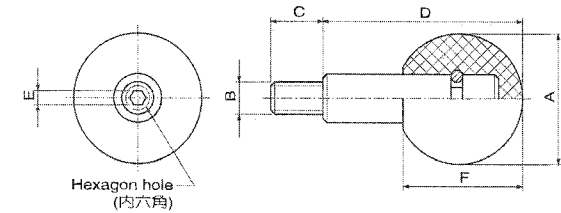
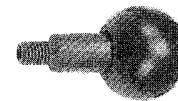

名稱 Name	材質 Material	表面處理 Surfaced process
旋鈕 Knob	電木 Bakelite (KU)	黑色 Black
軸 Spindle	鋼鐵 Steel (ST)	電鍍黑色 Matt black (B)

(mm)

Order No. 電木 (KU)	A	B	C	D	E	F
1060-25	25	M6	11	37.5	3	22.5
-32	32	M8	13	48	4	29
-40	40	M10	14	61	5	37
-50	50	M12	21	78	6	47

[6]

旋轉把手 Revolving Handles

1070

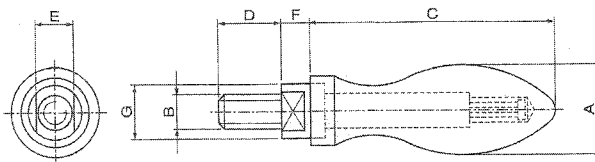

名稱 Name	材質 Material	表面處理 Surfaced process
把手 Handle	鋼鐵 Steel (ST) 鋁合金 Aluminum (AL) 塑膠 Plastic (KT)	鍍亮鉻 Chrome bright (CR) 鍍霧銀 Matt silver (EL)
軸 Spindle	鋼鐵 Steel (ST)	

(mm)

Order No. 鋼鐵 (ST)	Order No. 鋁 (AL)	Order No. 塑膠 (KT)	A	B	C	D	E	F	G
1070 - 14 - M 6	—	—	14	M6	49	11	8	5.5	10
- 16 - M 6	1071 - 16 - M 6	1072 - 16 - M 6	16	M6	49	11	8	5.5	10
- 20 - M 8	- 20 - M 8	- 20 - M 8	20	M8	61	13	10	7.5	13
- 25 - M10	- 25 - M10	- 25 - M10	25	M10	75	14	13	8	16
- 32 - M12	- 32 - M12	- 32 - M12	32	M12	95	21	17	11	20
- 36 - M16	- 36 - M16	- 36 - M16	36	M16	106	26	19	13	22

固定式把手 Fixed Handles

1080

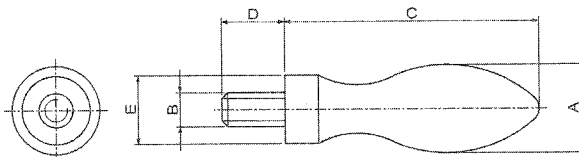

名稱 Name	材質 Material	表面處理 Surfaced process
把手 Handle	鋼鐵 Steel (ST) 鋁合金 Aluminum (AL)	鍍亮鉻 Chrome bright (CR) 鍍霧銀 Matt silver (EL)

(mm)

Order No. 鋼鐵 (ST)	Order No. 鋁 (AL)	A	B	C	D	E
1080 - 10 - M 4	1081 - 10 - M 4	10	M4	32	7	7
- 13 - M 5	- 13 - M 5	13	M5	40	9	8
- 16 - M 6	- 16 - M 6	16	M6	50	11	10
- 20 - M 8	- 20 - M 8	20	M8	64	13	13
- 25 - M10	- 25 - M10	25	M10	80	14	16
- 32 - M12	- 32 - M12	32	M12	100	21	20
- 36 - M16	- 36 - M16	36	M16	112	26	22

[7]

固定式把手 Fixed Handles

1085

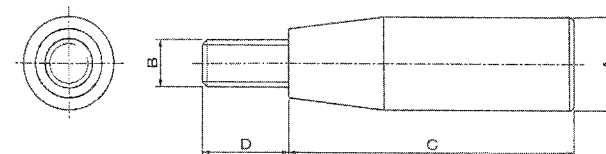

名稱 Name	材質 Material	表面處理 Surfaced process
把手 Handle	鋼鐵 Steel (ST) 不銹鋼 Stainless steel (SST)	鍍亮鉻 Chrome bright (CR) 鍍霧銀 Matt silver (EL)

(mm)

Order No. 鋼鐵 (ST)	Order No. 不銹鋼 (SST)	A	B	C	D
1085 - 13 - M 6	1086 - 13 - M 6	13	M6	46	13
- 16 - M 8	- 16 - M 8	16	M8	58	13
- 19 - M 8	- 19 - M 8	19	M8	58	13
- 22 - M10	- 22 - M10	22	M10	70	14
- 25 - M12	- 25 - M12	25	M12	94	20
- 28 - M16	- 28 - M16	28	M16	106	22

固定式把手 Fixed Handles

1087

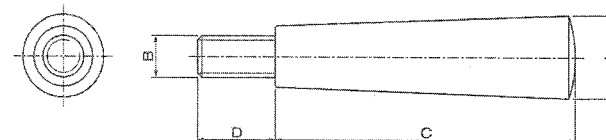
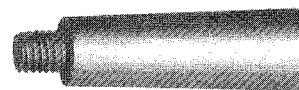

名稱 Name	材質 Material	表面處理 Surfaced process
把手 Handle	鋼鐵 Steel (ST)	鍍亮鉻 Chrome bright (CR) 鍍霧銀 Matt silver (EL)

(mm)

Order No. 鋼鐵 (ST)	A	B	C	D
1087 - 7 - M 4	7	M4	40	8
- 8 - M 5	8	M5	50	10
- 10 - M 6	10	M6	63	12
- 13 - M 8	13	M8	80	14
- 16 - M10	16	M10	100	16
- 20 - M12	20	M12	125	18
- 25 - M16	25	M16	160	20
- 32 - M20	32	M20	200	25

[8]

旋轉把手 Revolving Cylindrical Handles

1090

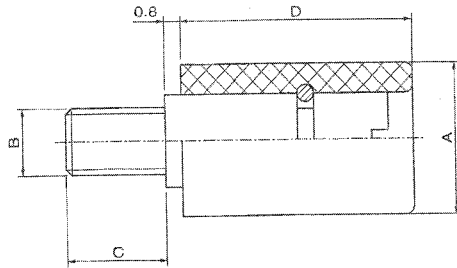

名稱 Name	材質 Material	表面處理 Surface process
把手 Handle	塑膠 Plastic (KT)	黑色 Black
軸 Spindle	鋼鐵 Steel (ST)	鍍鋅 Zincing (ZI)

(mm)

Order No. 鋼鐵 (ST)	A	B	C	D
1090 - 13 - M 6	13	M6	9	18
- 14 - M 6	14	M6	9	20
- 16 - M 6	16	M6	9	23

球形旋鈕 Ball Knobs

1110

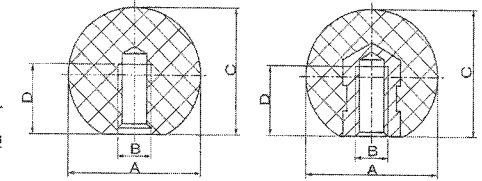
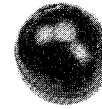

名稱 Name	材質 Material	表面處理 Surface process
旋鈕 Knob	電木 Bakelite (KU)	黑色 Black
內螺紋 Internal thread	銅 銅 (CU)	

(mm)

Order No. 電木 (KU)	Order No. 銅螺母 (CU)	A	B	C	D
1110 - 12 - M 4	1111 - 12 - M 4	12	M4	11.2	6.5
- 16 - M 4	- 16 - M 4	16	M4	15	7.2
- 16 - M 5	- 16 - M 5	16	M5	15	7.2
- 20 - M 5	- 20 - M 5	20	M5	18	9.1
- 20 - M 6	- 20 - M 6	20	M6	18	9.1
- 25 - M 6	- 25 - M 6	25	M6	22.5	11
- 25 - M 8	- 25 - M 8	25	M8	22.5	11
- 30 - M 8	- 30 - M 8	30	M8	26	14.5
- 32 - M 8	- 32 - M 8	32	M8	29	14.5
- 32 - M10	- 32 - M10	32	M10	29	14.5
- 35 - M10	- 35 - M10	35	M10	32.5	18
- 40 - M10	- 40 - M10	40	M10	37	18
- 40 - M12	- 40 - M12	40	M12	37	18
- 50 - M12	- 50 - M12	50	M12	46	21

長珠固定把手 Cylindrical Handles

1100

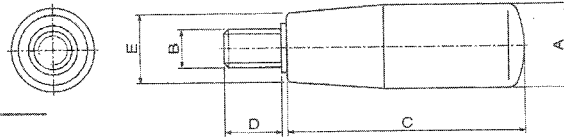

名稱 Name	材質 Material	表面處理 Surface process
把手 Handle	電木 Bakelite (KU)	黑色 Black
軸 Spindle	鋼鐵 Steel (ST)	鍍鋅 Zincing (ZI)

(mm)

Order No. 電木 (KU)	A	B	C	D	E
1100 - 18 - M 6	18	M6	40	12	15
- 21 - M 6	21	M6	50	13	17
- 21 - M 8	21	M8	50	13	17
- 23 - M 8	23	M8	65	14	19
- 23 - M10	23	M10	65	14	19
- 26 - M10	26	M10	80	16	21
- 26 - M12	26	M12	80	16	21
- 28 - M12	28	M12	90	16	22
- 31 - M12	31	M12	102	20	25
- 31 - M14	31	M14	102	20	25

[9]

球形旋鈕 Ball Knobs

1120

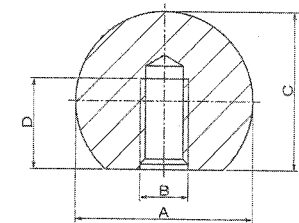

名稱 Name	材質 Material	表面處理 Surface process
旋鈕 Knob	鋼鐵 Steel (ST)	鍍亮鉻 Chrome bright (CR)
	鋁合金 Aluminum (AL)	

(mm)

Order No. 鋼鐵 (ST)	Order No. 鋁 (AL)	A	B	C	D
1120 - 16 - M 4	1121 - 16 - M 4	16	M4	15	7.2
- 20 - M 5	- 20 - M 5	20	M5	18	9.1
- 25 - M 6	- 25 - M 6	25	M6	22.5	11
- 32 - M 8	- 32 - M 8	32	M8	29	14.5
- 40 - M10	- 40 - M10	40	M10	37	18
- 50 - M12	- 50 - M12	50	M12	46	21

[10]

球形旋鈕
Ball Knobs

1130

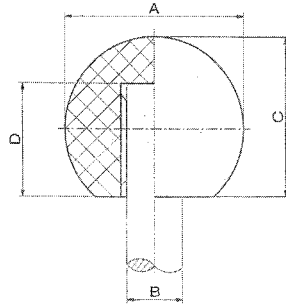
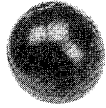

名稱 Name	材質 Material	表面處理 Surfaced process
旋鈕 Knob	電木 Bakelite (KU)	黑色 Black

(mm)

Order No. 電木 (KU)	A	B	C	D
1130 - 16 - B 4	16	B4	15	11
- 20 - B 5	20	B5	18	13
- 25 - B 6	25	B6	22.5	15
- 32 - B 8	32	B8	29	16
- 40 - B10	40	B10	37	20
- 50 - B12	50	B12	46	20

電木橢圓型旋鈕
Bakelite Ellipse Knobs

1145

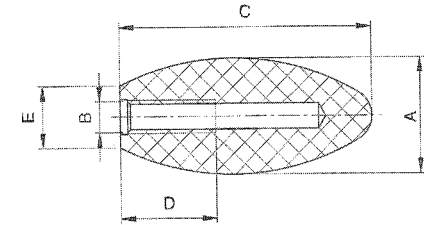
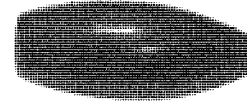

名稱 Name	材質 Material	表面處理 Surfaced process
旋鈕 Knob	電木 Bakelite (KU)	黑色 Black

(mm)

Order No. 電木 (KU)	A	B	C	D	E
1145 - 30 - M 8	30	M8	65	16	16
- 30 - M10	30	M10	65	21	16
- 30 - M12	30	M12	65	25	16
- 35 - M12	35	M12	85	25	22
- 35 - M16	35	M16	85	30	22

長珠旋鈕
Cylindrical Knobs

1140

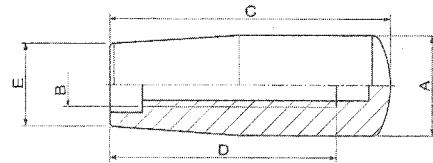
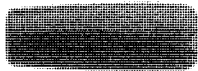

名稱 Name	材質 Material	表面處理 Surfaced process
旋鈕 Knob	電木 Bakelite (KU)	黑色 Black

(mm)

Order No. 電木 (KU)	A	B	C	D	E
1140 - 18 - M 6	18	M6	40	22	15
- 21 - M 6	21	M6	50	25	17
- 21 - M 8	21	M8	50	35	17
- 23 - M 8	23	M8	65	51	19
- 23 - M10	23	M10	65	52	19
- 26 - M10	26	M10	80	55	21
- 26 - M12	26	M12	80	59	21
- 28 - M12	28	M12	90	41	22
- 31 - M12	31	M12	102	58	25
- 31 - M14	31	M14	102	65	25

錐形旋鈕
Taper Knobs

1150

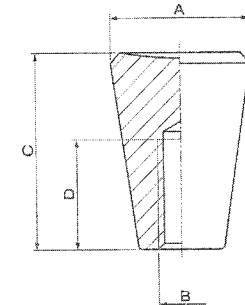

名稱 Name	材質 Material	表面處理 Surfaced process
旋鈕 Knob	電木 Bakelite (KU)	黑色 Black

(mm)

Order No. 電木 (KU)	A	B	C	D
1150 - 20 - M 5	20	M5	30	18
- 20 - M 6	20	M6	30	18
- 25 - M 6	25	M6	38	18
- 25 - M 8	25	M8	38	18
- 30 - M 8	30	M8	46	18
- 30 - M10	30	M10	46	18
- 35 - M10	35	M10	53	21
- 35 - M12	35	M12	53	21

電木圓錐型旋鈕 Bakelite Taper Knobs

1151

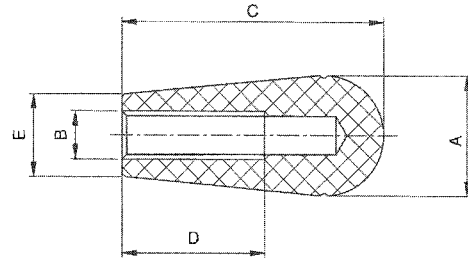

名稱	材質	表面處理
Name	Material	Surfaced process
旋鈕 Knob	電木 Bakelite (KU)	黑色 Black

(mm)

Order No. 電木 (KU)	A	B	C	D	E
1151 - 22 - M 6	22	M6	40	25	15
- 22 - M 8	22	M8	40	25	15
- 25 - M 8	25	M8	55	30	16
- 25 - M10	25	M10	55	30	16
- 32 - M10	32	M10	70	30	19
32 - M12	32	M12	70	30	19

Memo

齒輪桿把手 Gear Lever Handles

1160



Type A
球型旋鈕
Ball Knobs

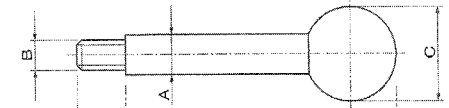

Type B
錐型旋鈕
Taper Knobs

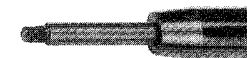
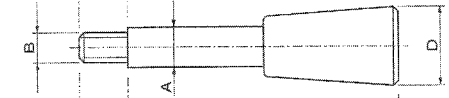

Type C
圓珠旋鈕
Cylindrical Knobs

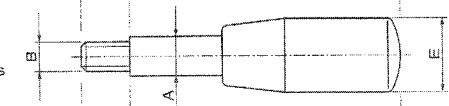

Type D
橢圓型旋鈕
Ellipse Knobs

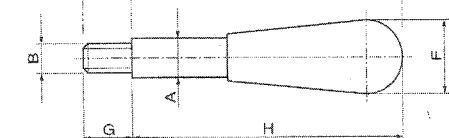

名稱	材質	表面處理
Name	Material	Surfaced process
旋鈕 Knob	電木 Bakelite (KU)	黑色 Black
桿 Lever	鋼 Steel (ST)	鍍霧銀 Matt silver (EL)

(mm)

Order No. 球型 Type A	Order No. 錐型 Type B	Order No. 圓珠型 Type C	Order No. 橢圓型 Type D	A	B	C	D	E	F	G	H
1160 - M 6 - 63	1161 - M 6 - 63	1162 - M 6 - 63	1163 - M 6 - 63	8	M6	22	16	18	22	9	63
- M 6 - 80	- M 6 - 80	- M 6 - 80	- M 6 - 80	8	M6	22	16	18	22	9	80
- M 6 - 100	- M 6 - 100	- M 6 - 100	- M 6 - 100	8	M6	22	16	18	22	9	100
- M 8 - 80	- M 8 - 80	- M 8 - 80	- M 8 - 80	10	M8	27	20	21	25	11	80
- M 8 - 100	- M 8 - 100	- M 8 - 100	- M 8 - 100	10	M8	27	20	21	25	11	100
- M 8 - 125	- M 8 - 125	- M 8 - 125	- M 8 - 125	10	M8	27	20	21	25	11	125
- M 10 - 100	- M 10 - 100	- M 10 - 100	- M 10 - 100	12	M10	34	25	23	30	14	100
- M 10 - 125	- M 10 - 125	- M 10 - 125	- M 10 - 125	12	M10	34	25	23	30	14	125
- M 10 - 160	- M 10 - 160	- M 10 - 160	- M 10 - 160	12	M10	34	25	23	30	14	160
- M 12 - 125	- M 12 - 125	- M 12 - 125	- M 12 - 125	14	M12	35	32	26	35	16	125
- M 12 - 160	- M 12 - 160	- M 12 - 160	- M 12 - 160	14	M12	35	32	26	35	16	160
- M 12 - 200	- M 12 - 200	- M 12 - 200	- M 12 - 200	14	M12	35	32	26	35	16	200
- M 14 - 160	- M 14 - 160	- M 14 - 160	-	16	M14	40	40	28	-	18	160
- M 14 - 200	- M 14 - 200	- M 14 - 200	-	16	M14	40	40	28	-	18	200
- M 14 - 250	- M 14 - 250	- M 14 - 250	-	16	M14	40	40	28	-	18	250

不銹鋼齒輪桿把手 ST. Steel Gear Lever Handles

1170



Type A
球型旋鈕
Ball Knobs

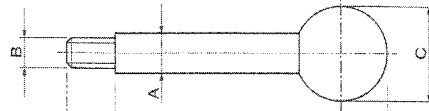

Type B
錐型旋鈕
Taper Knobs

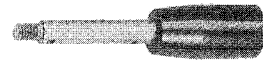
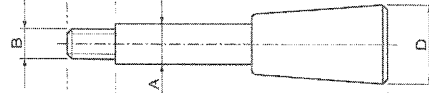

Type C
長珠旋鈕
Cylindrical Knobs

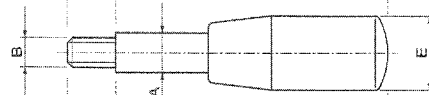

Type D
橢圓型旋鈕
Ellipse Knobs

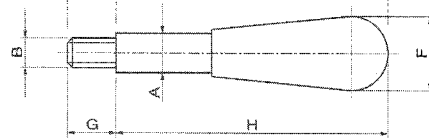

名稱 Name	材質 Material	表面處理 Surface process
旋鈕 Knob	電木 Bakelite (KU)	黑色 Black
桿 Lever	不銹鋼 Stainless steel (SST)	

(mm)

Order No. 球型 Type A	Order No. 錐型 Type B	Order No. 長珠型 Type C	Order No. 橢圓型 Type D	A	B	C	D	E	F	G	H
1170 - M6 - 63	1171 - M6 - 63	1172 - M6 - 63	1173 - M6 - 63	8	M6	22	16	18	22	9	63
- M6 - 80	- M6 - 80	- M6 - 80	- M6 - 80	8	M6	22	16	18	22	9	80
- M6 - 100	- M6 - 100	- M6 - 100	- M6 - 100	8	M6	22	16	18	22	9	100
- M8 - 80	- M8 - 80	- M8 - 80	- M8 - 80	10	M8	27	20	21	25	11	80
- M8 - 100	- M8 - 100	- M8 - 100	- M8 - 100	10	M8	27	20	21	25	11	100
- M8 - 125	- M8 - 125	- M8 - 125	- M8 - 125	10	M8	27	20	21	25	11	125
- M10 - 100	- M10 - 100	- M10 - 100	- M10 - 100	12	M10	34	25	23	30	14	100
- M10 - 125	- M10 - 125	- M10 - 125	- M10 - 125	12	M10	34	25	23	30	14	125
- M10 - 160	- M10 - 160	- M10 - 160	- M10 - 160	12	M10	34	25	23	30	14	160
- M12 - 125	- M12 - 125	- M12 - 125	- M12 - 125	14	M12	35	32	26	35	16	125
- M12 - 160	- M12 - 160	- M12 - 160	- M12 - 160	14	M12	35	32	26	35	16	160
- M12 - 200	- M12 - 200	- M12 - 200	- M12 - 200	14	M12	35	32	26	35	16	200
- M14 - 160	- M14 - 160	- M14 - 160	—	16	M14	40	40	28	—	18	160
- M14 - 200	- M14 - 200	- M14 - 200	—	16	M14	40	40	28	—	18	200
- M14 - 250	- M14 - 250	- M14 - 250	—	16	M14	40	40	28	—	18	250

凹槽式旋鈕 Waist Shaped Knobs

1180

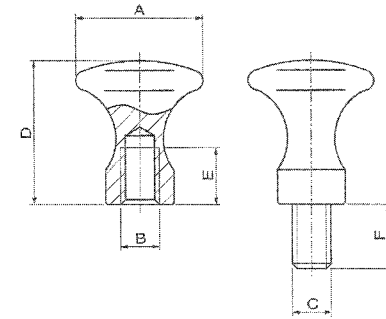

Type A
螺帽 Nut

Type B
螺柱 Screw

名稱 Name	材質 Material	表面處理 Surface process
旋鈕 Knob	鋼鐵 Steel (ST)	鍍亮鉻 Chrome bright (CR) 鍍霧鉻 Matt silver (EL)

(mm)

Order No. 球型 Type A	Order No. 螺帽 Type B	A	B	C	D	E	F
1180 - 16 - M5	1181 - 16 - M5	16	M5	M5	18	7	10
- 20 - M6	- 20 - M6	20	M6	M6	24	9	12
- 25 - M6	- 25 - M6	25	M6	M6	29	9	14
- 25 - M8	- 25 - M8	25	M8	M8	29	9	14
- 32 - M8	- 32 - M8	32	M8	M8	37	12	16
- 36 - M10	- 36 - M10	36	M10	M10	42	15	18

香菇型旋鈕 Mushroom Type Knobs

1190

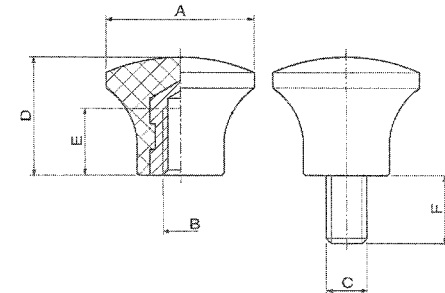
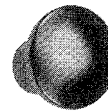

Type A
螺帽 Nut

Type B
螺柱 Screw

名稱 Name	材質 Material	表面處理 Surface process
旋鈕 Knob	電木 Bakelite (KU)	黑色 Black

(mm)

Order No. 球型 Type A	Order No. 螺帽 Type B	A	B	C	D	E	F
1190 - 17 - M5	1191 - 17 - M5	17	M5	M5	14	7	9
- 21 - M6	- 21 - M6	21	M6	M6	17	11	10
- 25 - M6	- 25 - M6	25	M6	M6	21	11	10
- 30 - M8	- 30 - M8	30	M8	M8	29	12	14

塑膠旋鈕
Plastic Knobs

1195
GAMM

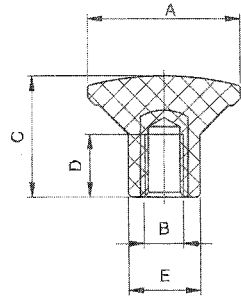

名稱 Name	材質 Material	表面處理 Surfaced process
旋鈕 Knob	尼龍加玻璃纖維 (KT)	黑色 Black

(mm)

Order No. 尼龍加玻璃纖維 (KT)	A	B	C	D	E
1195 - 26 - M4	26	M4	17	8	12
- 26 - M5	26	M5	17	8	12
- 26 - M6	26	M6	17	8	12
- 32 - M6	32	M6	24	13	15
- 32 - M8	32	M8	24	13	15

塑膠旋鈕
Plastic Knobs

1197
GAMM

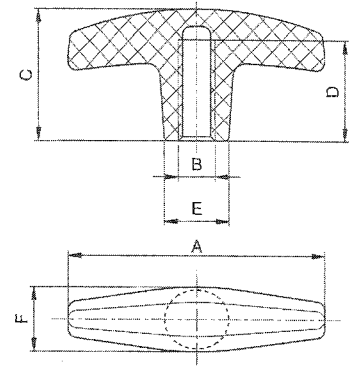
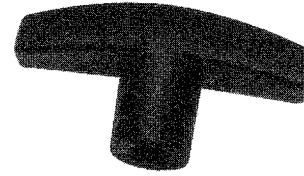

名稱 Name	材質 Material	表面處理 Surfaced process
旋鈕 Knob	尼龍加玻璃纖維 (KT)	黑色 Black

(mm)

Order No. 尼龍加玻璃纖維 (KT)	A	B	C	D	E	F
1197 - 57 - M6	57	M6	30	13	14.5 x 13	15
- 57 - M8	57	M8	30	15	14.5 x 13	15

電木旋鈕
Bakelite Knobs

1196
GAMM

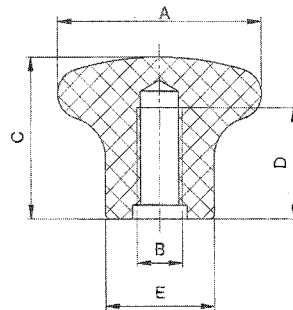

名稱 Name	材質 Material	表面處理 Surfaced process
旋鈕 Knob	電木 Bakelite (KU)	黑色 Black

(mm)

Order No. 電木 (KU)	A	B	C	D	E
1196 - 35 - M6	35	M6	35	20	17
- 35 - M8	35	M8	35	20	17
- 45 - M8	45	M8	34	23	24
- 45 - M10	45	M10	34	23	24
- 45 - M12	45	M12	34	23	24

U型把手
Cabinet "U" Handles

1200

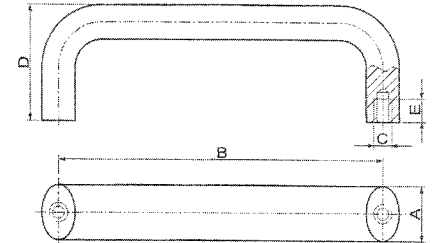
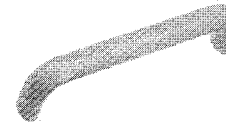

名稱 Name	材質 Material	表面處理 Surfaced process
把手 Handle	鋁合金 Aluminum (AL)	原色 Natural (N) 黑色烤漆 Paint black (BK) 紅色烤漆 Paint red (RD) 鍍霧銀 Matt silver (EL) 陽極黑亮 Anodized black (AB)

(mm)

Order No. 鋁合金 (AL)	A	B	C	D	E
1200 - 20 - 100	20	100	M6	50	10
- 20 - 112	20	112	M6	50	10
- 20 - 128	20	128	M6	50	10
- 20 - 160	20	160	M6	50	10
- 26 - 112	26	112	M8	55	12
- 26 - 117	26	117	M8	55	12
- 26 - 128	26	128	M8	55	12
- 26 - 160	26	160	M8	55	12
- 26 - 179	26	179	M8	55	12
- 26 - 190	26	192	M8	55	12
- 26 - 300	26	300	M8	55	12
- 26 - 400	26	400	M6	55	12

U型把手 Cabinet "U" Handles

1201

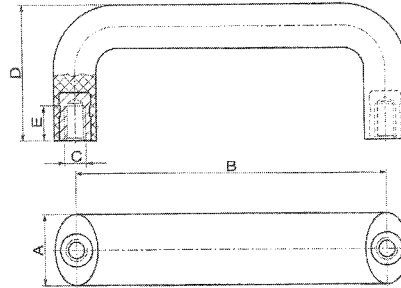
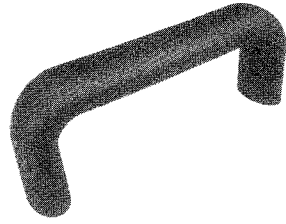

名稱 Name	材質 Material	表面處理 Surface process
把手 Handle	尼龍加玻璃纖維 (KT)	黑色 Black
軸 Spindle	銅 Capper (CU)	黑色 Black

(mm)

Order No. 尼龍加玻璃纖維 (KT)	A	B	C	D	E
1201 - 86 - M6	24	86	M6	44	12
- 117 - M6	26	117	M6	48	13
- 117 - M8	26	117	M8	48	13
- 179 - M8	28	179	M8	57	13
- 300 - M10	33	300	M10	64	17

U型把手 Cabinet "U" Handles

1203

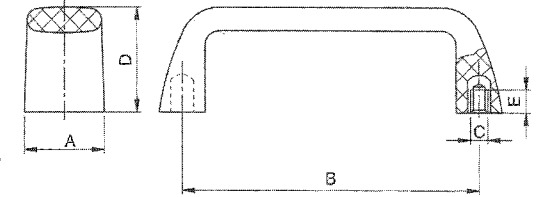
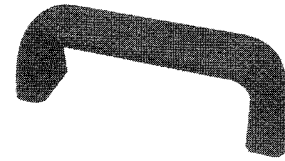

名稱 Name	材質 Material	表面處理 Surface process
把手 Handle	尼龍加玻璃纖維 (KT)	黑色 Black

(mm)

Order No. 尼龍加玻璃纖維 (KT)	A	B	C	D	E
1203 - 105 - M5	26	105	M5	37	9
- 105 - M6	26	105	M6	37	9
- 110 - M5	26	110	M5	40	9
- 110 - M6	26	110	M6	40	9
- 117 - M5	26	117	M5	40	9
- 117 - M6	26	117	M6	40	9
- 117 - M8	26	117	M8	40	9

U型把手 Cabinet "U" Handles

1202

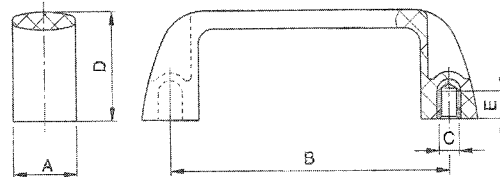
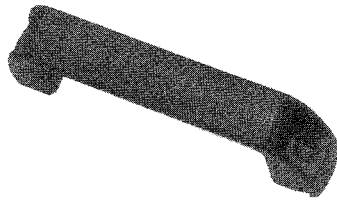

名稱 Name	材質 Material	表面處理 Surface process
把手 Handle	尼龍加玻璃纖維 (KT)	黑色 Black

(mm)

Order No. 尼龍加玻璃纖維 (KT)	A	B	C	D	E
1202 - 93.5 - M5	21	93.5	M5	36	9
- 93.5 - M6	21	93.5	M6	36	9
- 117 - M6	26	117	M6	41	9
- 117 - M8	26	117	M8	41	9
- 132 - M6	27	132	M6	45	9
- 132 - M8	27	132	M8	45	9
- 179 - M8	28	179	M8	50	9

U型把手 Cabinet "U" Handles

1204

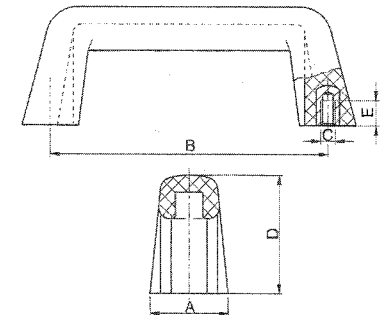
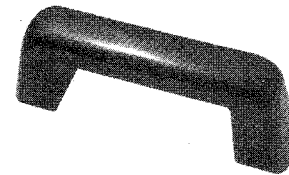

名稱 Name	材質 Material	表面處理 Surface process
把手 Handle	電木 Bakelite (KU)	黑色 Black

(mm)

Order No. 電木 (KU)	A	B	C	D	E
1204 - 105 - M6	30	105	M6	48	13
- 110 - M6	30	110	M6	48	9
- 117 - M8	30	117	M8	48	15
- 120 - M6	30	120	M6	48	9
- 120 - M8	30	120	M8	48	9
- 132 - M8	36	132	M8	56	15
- 132 - M10	36	132	M10	56	16

U型把手 Cabinet "U" Handles

1205

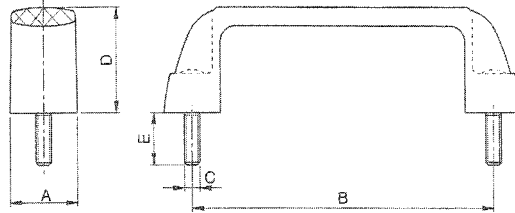
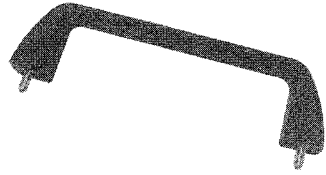

名稱 Name	材質 Material	表面處理 Surface process
把手 Handle	尼龍加玻璃纖維 (KT)	黑色 Black
軸 Spindle	鋼鐵 Steel (ST)	

(mm)

Order No. 尼龍加玻璃纖維 (KT)	A	B	C	D	E
1205 - 93.5 - M6	21	93.5	M6	36	15
- 117 - M6	26	117	M6	41	15
- 132 - M6	27	132	M6	45	15
- 179 - M6	28	179	M6	50	15

U型把手 Cabinet "U" Handles

1206

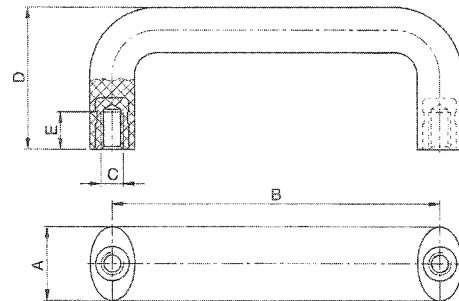
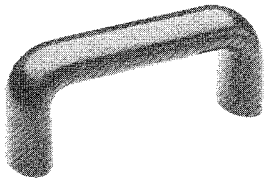

名稱 Name	材質 Material	表面處理 Surface process
把手 Handle	電木 Bakelite (KU)	黑色 Black
軸 Spindle	銅 Copper (CU)	

(mm)

Order No. 電木 (KU)	A	B	C	D	E
1206 - 86 - M6	26	86	M6	43	12
- 117 - M8	30	117	M8	54	13
- 179 - M8	30	179	M8	62	13

[21]

U型把手 Cabinet "U" Handles

1210

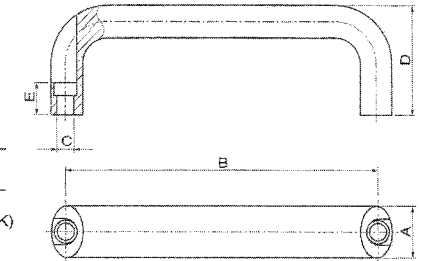
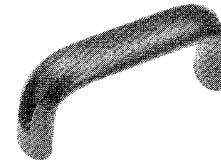

名稱 Name	材質 Material	表面處理 Surface process
把手 Handle	鋁合金 Aluminum (AL)	原色 Natural (N) 黑色烤漆 Paint black (BK) 紅色烤漆 Paint red (RD) 鍍霧銀 Matt silver (EL)

(mm)

Order No. 鋁合金 (AL)	A	B	C	D	E
1210 - 116	26	116	6.3	55	17
- 132	26	132	6.3	55	17
- 164	26	164	6.3	55	17
- 196	26	196	6.3	55	17

弓型把手 Bow Handles

1211

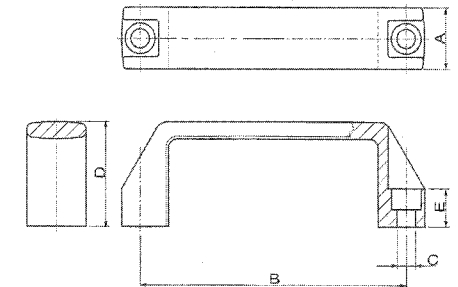
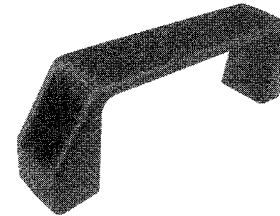

名稱 Name	材質 Material	表面處理 Surface process
把手 Handle	尼龍加玻璃纖維 (KT)	黑色 Black (BK) 橘色 Orange (OR)

(mm)

Order No. 尼龍加玻璃纖維 (KT)	A	B	C	D	E
1211 - 94	21	94	6.5	36	13
- 117	26	117	8.5	41	15
- 132	27	132	8.5	45	16
- 179	28	179	8.5	50	17
- 235	31	235	10.5	54	20

[22]

U型把手 Cabinet "U" Handles

1212

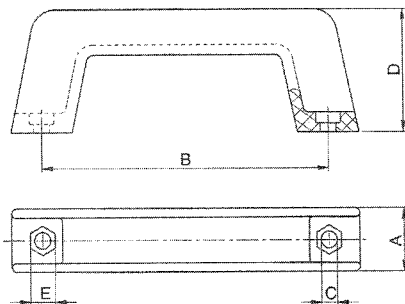
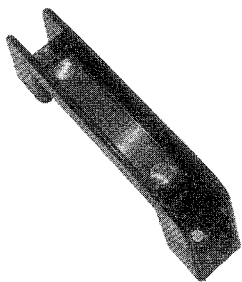

名稱 Name	材質 Material	表面處理 Surfaced process
把手 Handle	尼龍加玻璃纖維 (KT)	黑色 Black

(mm)

Order No. 尼龍加玻璃纖維 (KT)	A	B	C	D	E
1212 - 110 - B6	26	110	B6	49	10
- 117 - B6	26	117	B6	49	10
- 132 - B8	30	132	B8	57	13

U型把手 Cabinet "U" Handles

1220

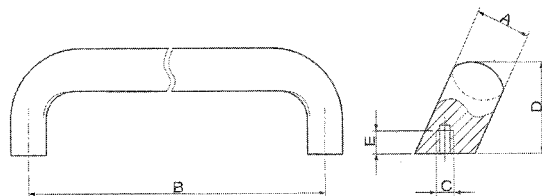

名稱 Name	材質 Material	表面處理 Surfaced process
把手 Handle	鋁合金 Aluminum (AL)	原色 Natural (N) 黑色烤漆 Paint black (BK) 紅色烤漆 Paint red (RD) 鍍霧銀 Matt silver (EL)

(mm)

Order No. 鋁合金 (AL)	A	B	C	D	E
1220 - 20 - 112	20	112	M6	48	10
- 20 - 128	20	128	M6	48	10
- 26 - 128	26	128	M8	54	12
- 26 - 160	26	160	M8	54	12

[23]

不銹鋼U型把手 ST. Steel Cabinet "U" Handles

1230

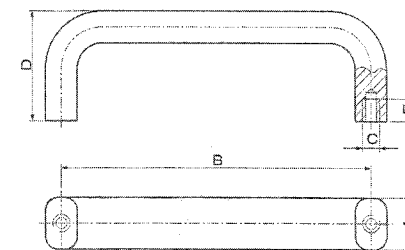
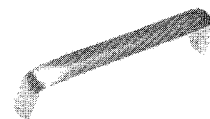

名稱 Name	材質 Material
把手 Handle	不銹鋼Stainless steel (SST)

(mm)

Order No. 不銹鋼 (SST)	A	B	C	D	E
1230 - 100	20	100	M6	45	10
- 112	20	112	M6	45	10
- 117	20	117	M6	45	10
- 128	20	128	M6	45	10
- 150	20	150	M8	45	10
- 179	20	179	M8	45	10
- 250	20	250	M8	45	10
- 288	20	288	M8	45	10
- 350	20	350	M8	45	10

U型把手 Cabinet "U" Handles

1240

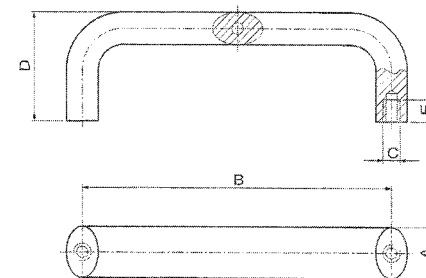

名稱 Name	材質 Material	表面處理 Surfaced process
把手 Handle	鋁合金 Aluminum (AL)	塑膠披覆 Plastic coating 黑色 Black

(mm)

Order No. 鋁合金 (AL)	A	B	C	D	E
1240 - 112	28	112	M8	55	10
- 117	28	117	M8	55	10
- 128	28	128	M8	55	10
- 160	28	160	M8	55	10
- 179	28	179	M8	55	10
- 192	28	192	M8	55	10

[24]

U型把手 Cabinet "U" Handles

1250

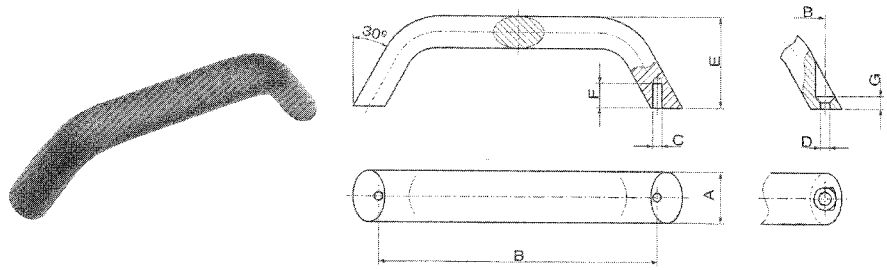

名稱 Name	材質 Material	表面處理 Surfaced process
把手 Handle	鋁合金 Aluminum (AL)	原色 Natural (N) 黑色烤漆 Paint black (BK) 紅色烤漆 Paint red (RD) 鍍霧銀 Matt silver (EL)

Type A
下鎖 Bellow Fix

Type B
上鎖 Front Fix

(mm)

Order No. 下鎖 Type A	Order No. 上鎖 Type B	A	B	C	D	E	F	G
1250 - 120	1251 - 120	20	120	M5	5.3	41	10	5

U型把手 Cabinet "U" Handles

1270

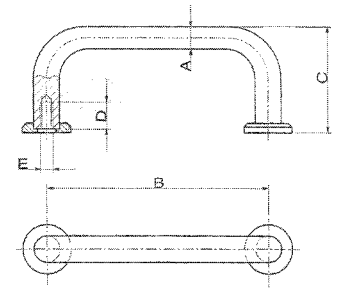

名稱 Name	材質 Material	表面處理 Surfaced process
把手 Handle	鋼鐵 Steel (ST)	鍍霧銀 Matt silver (EL)
墊片 Location disc	鋼鐵 Steel (ST)	鍍亮鉻 Chrome bright (CR)

(mm)

Order No. 鋼鐵 (ST)	A	B	C	D	E
1270 - 8 - 88	8	88	43	12	M4
- 8 - 100	8	100	43	12	M4
- 8 - 120	8	120	43	12	M4
- 10 - 88	10	88	43	12	M5
- 10 - 100	10	100	43	12	M5
- 10 - 110	10	110	43	12	M5
- 10 - 120	10	120	43	12	M5
- 10 - 180	10	180	43	12	M5
- 10 - 200	10	200	43	12	M5
- 10 - 235	10	235	43	12	M5

U型把手 Cabinet "U" Handles

1260

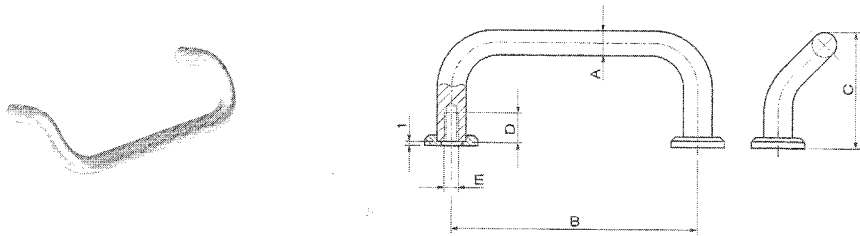

名稱 Name	材質 Material	表面處理 Surfaced process
把手 Handle	鋼鐵 Steel (ST)	鍍亮鉻
墊片 Location disc	鋼鐵 Steel (ST)	鍍亮鉻 Chrome bright (CR)

(mm)

Order No. 鋼鐵 (ST)	A	B	C	D	E
1260 - 88	10	88	46	12	M5
- 100	10	100	46	12	M5
- 120	10	120	46	12	M5

[25]

U型折疊把手 "U" Collapsible Handles

1271

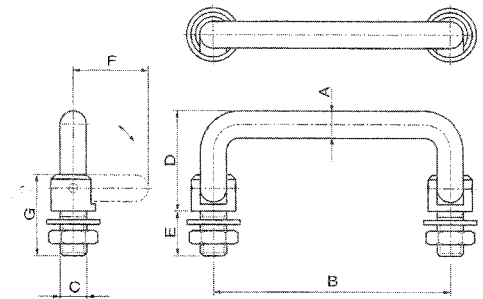
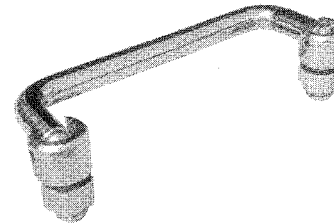

名稱 Name	材質 Material	表面處理 Surfaced process
把手 Handle	鋼鐵 Steel (ST)	鍍亮鉻 Chrome bright (CR)
螺帽 Nuts	鋼鐵 Steel (ST)	電鍍黑色 Matt black (B)

(mm)

Order No. 鋼鐵 (ST)	A	B	C	D	E	F	G
1271 - 100 - 3/8	9	100	3/8-24	52	15	51	28
- 120 - M10	10	120	M10 x1P	43	14	34	28
- 180 - M10	10	180	M10 x1P	43	14	34	28

[26]

不銹鋼U型把手 ST. Steel Cabinet "U" Handles

1280

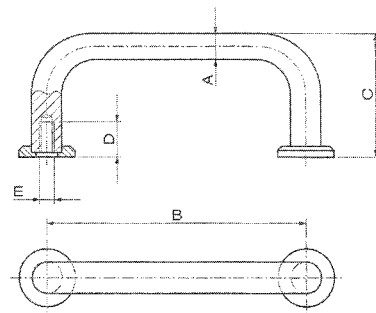

名稱 Name	材質 Material
把手 Handle	不銹鋼 Stainless steel (SST)
墊片 Location disc	不銹鋼 Stainless steel (SST)

(mm)

Order No. 不銹鋼 (SST)	A	B	C	D	E
1280 - 8 - 88	8	88	43	12	M4
- 8 - 100	8	100	43	12	M4
- 8 - 120	8	120	43	12	M4
- 10 - 88	10	88	43	12	M5
- 10 - 100	10	100	43	12	M5
- 10 - 120	10	120	43	12	M5
- 10 - 180	10	180	43	12	M5
- 10 - 200	10	200	43	12	M5
- 10 - 235	10	235	43	12	M5

不銹鋼U型折疊把手 ST. Steel "U" Collapsible Handles

1281

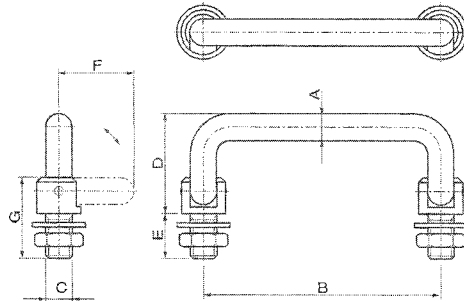
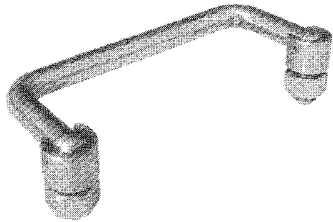

名稱 Name	材質 Material
把手 Handle	不銹鋼 Stainless steel (SST)
墊片 Location disc	不銹鋼 Stainless steel (SST)

(mm)

Order No. 不銹鋼 (SST)	A	B	C	D	E	F	G
1281 - 100 - 3/8	9	100	3/8-24	52	15	51	28
- 120 - M10	10	120	M10 x1P	43	14	34	28
- 180 - M10	10	180	M10 x1P	43	14	34	28

[27]

不銹鋼櫥櫃把手 ST. Steel Arch Handles

1282

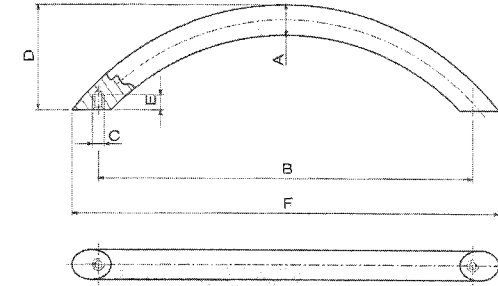

名稱 Name	材質 Material
把手 Handle	不銹鋼 Stainless steel (SST)

(mm)

Order No. 不銹鋼 (SST)	A	B	C	D	E	F
1282 - 10 - 64	10	64	M4	35	5	75
- 10 - 96	10	96	M4	35	5	111
- 10 - 128	10	128	M4	35	5	146
- 10 - 160	10	160	M4	35	5	181
- 10 - 192	10	192	M4	35	5	219

U型把手 Cabinet "U" Handles

1290

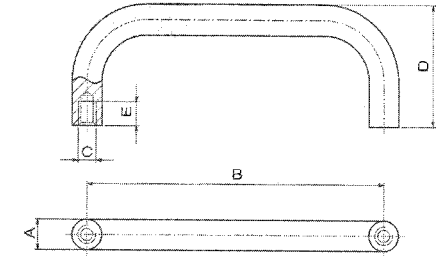
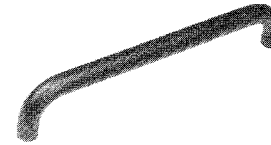

名稱 Name	材質 Material	表面處理 Surfaced process
把手 Handle	鋁合金 Aluminum (AL)	原色 Natural (N) 黑色烤漆 Paint black (BK) 紅色烤漆 Paint red (RD) 鍍霧銀 Matt silver (EL)

(mm)

Order No. 鋁合金 (AL)	A	B	C	D	E
1290 - 20 - 200	20	200	M8	70	15
- 20 - 250	20	250	M8	70	15
- 20 - 300	20	300	M8	70	15
- 20 - 350	20	350	M8	70	15
- 20 - 400	20	400	M8	70	15
- 28 - 250	28	250	M10	78	15
- 28 - 300	28	300	M10	78	15
- 28 - 350	28	350	M10	78	15
- 28 - 400	28	400	M10	78	15

[28]

U型把手 Cabinet "U" Handles

1300

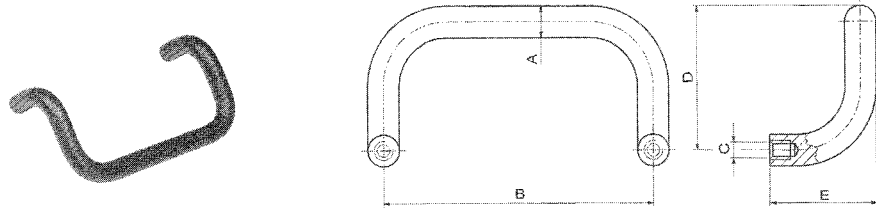

名稱 Name	材質 Material	表面處理 Surfaced process
把手 Handle	鋁合金 Aluminum (AL)	原色 Natural (N) 黑色烤漆 Paint black (BK)

(mm)

Order No. 鋁合金 (AL)	A	B	C	D	E
1300 - 20 - 200	20	200	M8	105	68
- 20 - 300	20	300	M8	105	68
- 28 - 250	28	250	M10	120	78
- 28 - 350	28	350	M10	120	78

不銹鋼U型把手 ST. Steel Cabinet "U" Handles

1301

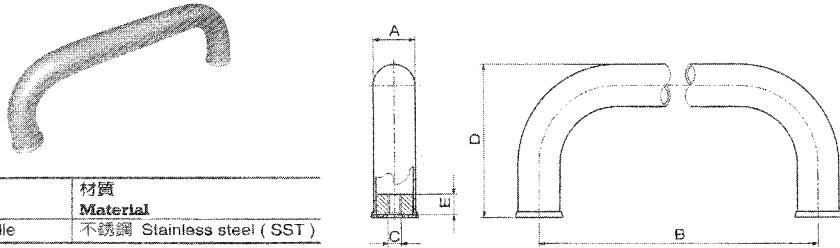

名稱 Name	材質 Material
把手 Handle	不銹鋼 Stainless steel (SST)

(mm)

Order No. 不銹鋼 (SST)	A	B	C	D	E
1301 - 25 - 155	25	155	M8	68	15
- 25 - 200	25	200	M8	68	15
- 25 - 250	25	250	M8	68	15
- 25 - 300	25	300	M8	68	15
- 25 - 350	25	350	M8	68	15
- 32 - 250	32	250	M10	78	15
- 32 - 300	32	300	M10	78	15
- 32 - 350	32	350	M10	78	15
- 32 - 400	32	400	M10	78	15
- 32 - 450	32	500	M10	78	15

[29]

不銹鋼U型把手 ST. Steel Cabinet "U" Handles

1302

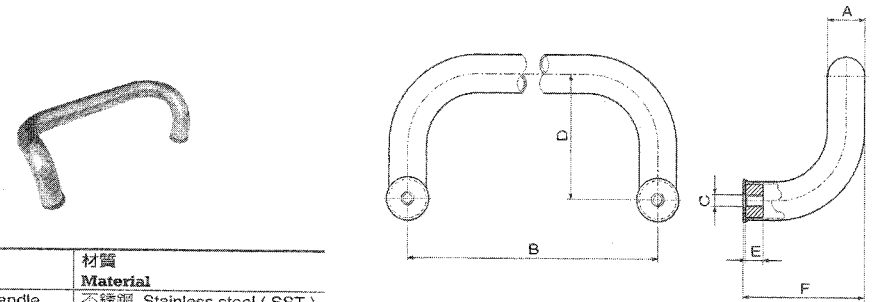

名稱 Name	材質 Material
把手 Handle	不銹鋼 Stainless steel (SST)

(mm)

Order No. 不銹鋼 (SST)	A	B	C	D	E	F
1302 - 25 - 200	25	200	M8	105	15	68
- 25 - 300	25	300	M8	105	15	68
- 32 - 250	32	250	M10	120	15	78
- 32 - 350	32	350	M10	120	15	78

管型把手 Tubular Handles

1310

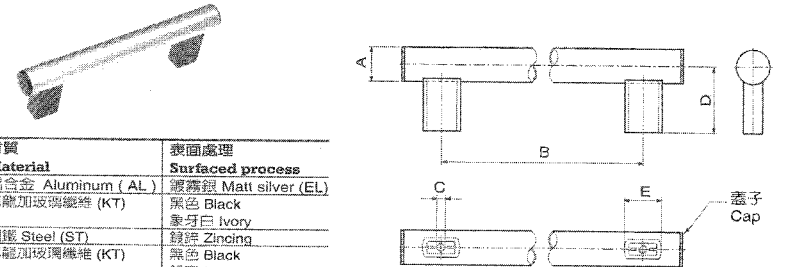

名稱 Name	材質 Material	表面處理 Surfaced process
圓管 Round tube	鋁合金 Aluminum (AL)	霧霧銀 Matt silver (EL)
支座 Seat	尼龍加玻璃纖維 (KT)	黑色 Black 象牙白 Ivory
鋼螺絲 Steel bolt	鋼鍍 Steel (ST)	鍍鋅 Zincing
蓋子 Cap	尼龍加玻璃纖維 (KT)	黑色 Black 霧銀 Brush silver

(mm)

Order No. 鋁合金 (AL)	A	B	C	D	E
1310 - 200	30	200	M8	60	35
- 250	30	250	M8	60	35
- 300	30	300	M8	60	35
- 400	30	400	M8	60	35
- 500	30	500	M8	60	35
- 600	30	600	M8	60	35
- B	30	B 自由設計 Free design	M8	60	35

[30]

不銹鋼管型把手 ST. Steel Tubular Handles

1311

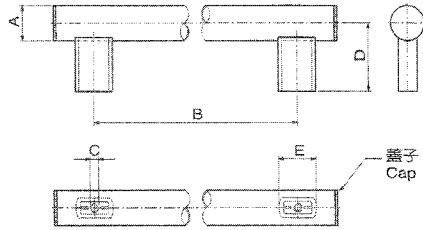
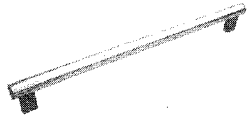

名稱 Name	材質 Material	表面處理 Surfaced process
圓管 Round tube	不銹鋼 Stainless steel (SST)	黑色 Black
支座 Seat	尼龍加玻璃纖維 (KT)	象牙白 Ivory
鋼螺栓 Steel bolt	鍍鋅 Steel (ST)	鍍鋅 Zincing
蓋子 Cap	尼龍加玻璃纖維 (KT)	黑色 Black 鍍亮 Brush silver

(mm)

Order No. 不銹鋼 (SST)	A	B	C	D	E
1311 - 200	31.8	200	M8	62	35
- 250	31.8	250	M8	62	35
- 300	31.8	300	M8	62	35
- 400	31.8	400	M8	62	35
- 490	31.8	490	M8	62	35
- 500	31.8	500	M8	62	35
- 595	31.8	595	M8	62	35
- 600	31.8	600	M8	62	35
- 918	31.8	918	M8	62	35
- B	31.8	B	M8	62	35
自由設計 Free design					

管型把手 Tubular Handles

1330

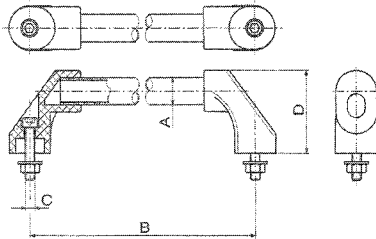
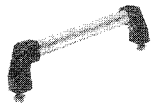

名稱 Name	材質 Material	表面處理 Surfaced process
圓管 Round tube	鋁合金 Aluminum (AL)	鍍霧銀 Matt silver (EL)
支座 Seat	尼龍加玻璃纖維 (KT)	黑色 Black
鋼螺栓 Steel bolt	鋼鍍 Steel (ST)	染黑 Dyed black (B)

(mm)

Order No. 鋁合金 (AL)	A	B	C	D
1330 - 180	30	180	M10	80
- 200	30	200	M10	80
- 250	30	250	M10	80
- 300	30	300	M10	80
- 350	30	350	M10	80
- 400	30	400	M10	80
- 500	30	500	M10	80
- 600	30	600	M10	80
- 700	30	700	M10	80
- B	30	B	M10	80
自由設計 Free design				

[31]

方管型把手 Square Tubular Handles

1331

NEW

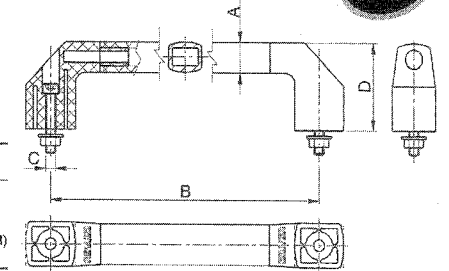

名稱 Name	材質 Material	表面處理 Surfaced process
方管 Square tube	鋁合金 Aluminum (AL)	鍍霧銀 Matt silver (EL)
支座 Seat	塑膠 (KT)	陽極電鍍 Anodized
鋼螺栓 Steel bolt	黑色 Black	紅色 Natural (AN) 黑色 Black (ABK)
	鋼鍍 Steel (ST)	紅色 Red (ARD) 橘色 Orange (AOR)
	染黑 Dyed black (B)	藍色 Blue (ABL) 黃色 Yellow (AYE)

(mm)

Order No. 鋁合金 (AL)	A	B	C	D
1331 - 180	24 x 27	180	M8	69
- 200	24 x 27	200	M8	69
- 250	24 x 27	250	M8	69
- 300	24 x 27	300	M8	69
- 350	24 x 27	350	M8	69
- 400	24 x 27	400	M8	69
- 500	24 x 27	500	M8	69
- 600	24 x 27	600	M8	69
- 700	24 x 27	700	M8	69

不銹鋼弧型把手 ST. Steel Arcuate Handles

1400

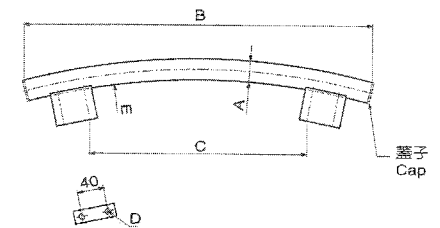
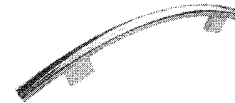

名稱 Name	材質 Material	表面處理 Surfaced process
圓管 Round tube	不銹鋼 Stainless steel (SST)	黑色 Black
支座 Seat	鋁合金 Aluminum (AL)	鍍霧銀 Silver
鋼螺栓 Steel bolt	鋼鍍 Steel (ST)	鍍鋅 Zincing
蓋子 Cap	尼龍加玻璃纖維 (KT)	黑色 Black 鍍亮 Brush silver

(mm)

Order No. 不銹鋼 (SST)	A	B	C	D	E
1400 - 531 - 330	31.8	531	330	M8	R1030
- 560 - 350	31.8	560	350	M8	R2798
- 700 - 530	31.8	700	530	M8	R3000
- 718 - 388	31.8	718	388	M8	R720
- 880 - 680	31.8	880	680	M8	R2050
- 900 - 630	31.8	900	630	M8	R3090
- 900 - 672	31.8	900	672	M8	R1568
- 950 - 750	31.8	950	750	M8	R2050
- 960 - 780	31.8	960	780	M8	R3320
- B - C - E	31.8	B	C	M8	E
自由設計 Free design		自由設計 Free design	自由設計 Free design	自由設計 Free design	

[32]

不銹鋼弧型把手 ST. Steel Arcuate Handles

1401

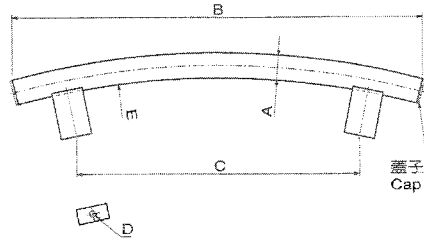

名稱 Name	材質 Material	表面處理 Surfaced process
圓管 Round tube	不銹鋼 Stainless steel (SST)	
支座 Seat	鋁合金 Aluminum (AL)	黑色 Black 銀色 Silver
	尼龍加玻璃纖維 (KT)	黑色 Black 象牙色 Ivory
鋼螺絲 Steel bolt	鋼鐵 Steel (ST)	鍍鋅 Zincmg
蓋子 Cap	尼龍加玻璃纖維 (KT)	黑色 Black 銀亮 Brush silver

(mm)

Order No. 不銹鋼 (SST)	A	B	C	D	E
1401 - 376 - 180	31.8	376	180	M8	R1748
- 620 - 457	31.8	620	457	M8	R950
- 700 - 529	31.8	700	529	M8	R1654
- 700 - 600	31.8	700	600	M8	R1729
- 717 - 543	31.8	717	543	M8	R2038
- 800 - 590	31.8	800	590	M8	R1598
- 800 - 695	31.8	800	595	M8	R1598
- B - C - E	31.8	B	C	M8	E

自由設計 Free design

不銹鋼弧型把手 ST. Steel Arcuate Handles

1402

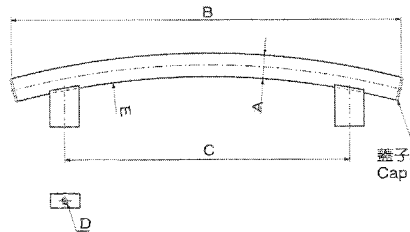

名稱 Name	材質 Material	表面處理 Surfaced process
圓管 Round tube	不銹鋼 Stainless steel (SST)	
支座 Seat	鋁合金 Aluminum (AL)	黑色 Black 銀色 Silver
	尼龍加玻璃纖維 (KT)	黑色 Black 象牙色 Ivory
鋼螺絲 Steel bolt	鋼鐵 Steel (ST)	鍍鋅 Zincmg
蓋子 Cap	尼龍加玻璃纖維 (KT)	黑色 Black 銀亮 Brush silver

(mm)

Order No. 不銹鋼 (SST)	A	B	C	D	E
1402 - 530 - 400	31.8	530	400	M8	R1168
- 600 - 425	31.8	600	425	M8	R1168
- 700 - 600	31.8	700	600	M8	R1700
- 796 - 600	31.8	796	600	M8	R4234
- 940 - 850	31.8	940	850	M8	R2968
- 980 - 800	31.8	980	800	M8	R4000
- B - C - E	31.8	B	C	M8	E

自由設計 Free design

曲柄把手 Cranked Handles

2010

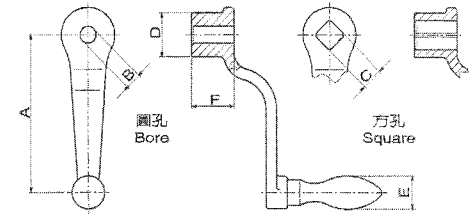
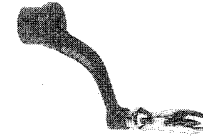

名稱 Name	材質 Material	表面處理 Surfaced process
曲柄 Cranked	鑄造鋼 Cast-steel	鍍亮鉻 Chrome bright (CR)
	鋼鐵 Steel (ST)	鍍霧銀 Matt silver (EL)
把手 Handle	鋼鐵 Steel (ST)	

(mm)

Order No. 圓孔 (Bore)	Order No. 方孔 (Square)	A	B	C	D	E	F
2010 - 63 - B 6	2010 - 63 - V10	63	B6	V10	20	16	20
- 80 - B 8	- 80 - V10	80	B8	V10	24	16	24
- 100 - B10	- 100 - V12	100	B10	V12	28	20	28
- 125 - B10	- 125 - V14	125	B10	V14	34	25	34
- 160 - B14	- 160 - V17	160	B14	V17	38	25	38
- 200 - B17	- 200 - V19	200	B17	V19	44	32	44
- 250 - B17	- 250 - V22	250	B17	V22	48	36	48
- 315 - B20	- 315 - V24	315	B20	V24	54	36	54

曲柄把手 Cranked Handles

2020

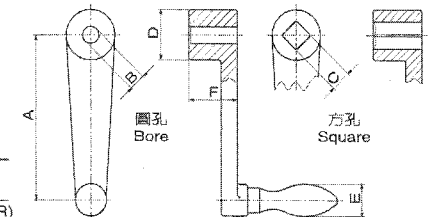
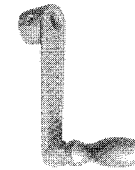

名稱 Name	材質 Material	表面處理 Surfaced process
曲柄 Cranked	脫臘鑄造 Precision casting	鍍亮鉻 Chrome bright (CR)
	鋼鐵 Steel (ST)	鍍霧銀 Matt silver (EL)
	鑄造鋼 Cast-steel	
把手 Handle	鋼鐵 Steel (ST)	

(mm)

Order No. 圓孔 (Bore)	Order No. 方孔 (Square)	A	B	C	D	E	F
2020 - 63 - B 6	2020 - 63 - V10	63	B6	V10	20	16	20
- 80 - B 8	- 80 - V10	80	B8	V10	24	16	24
- 100 - B10	- 100 - V12	100	B10	V12	28	20	28
- 125 - B10	- 125 - V14	125	B10	V14	34	25	34
- 160 - B14	- 160 - V17	160	B14	V17	38	25	38
- 200 - B17	- 200 - V19	200	B17	V19	44	32	44
- 250 - B17	- 250 - V22	250	B17	V22	48	36	48

曲柄把手 Cranked Handles

2030

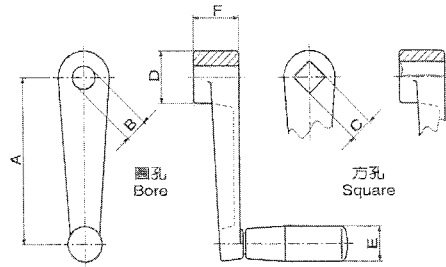

名稱 Name	材質 Material	表面處理 Surfaced process
曲柄 Cranked	鋁合金 Aluminum (AL)	電鍍黑色 Matt black (B)
把手 Handle	電木 Bakelite (KU)	鍍霧銀 Matt silver (EL)
	黑色 Black	

(mm)

Order No. 圓孔 (Bore)	Order No. 方孔 (Square)	A	B	C	D	E	F
2030 - 50 - B 8	2030 - 50 - V 8	50	B8	V8	16	14	18
- 64 - B10	- 64 - V10	64	B10	V10	19	18	20
- 80 - B10	- 80 - V10	80	B10	V10	23	21	24
- 100 - B12	- 100 - V12	100	B12	V12	27	23	28
- 125 - B14	- 125 - V14	125	B14	V14	32	26	34
- 160 - B17	- 160 - V17	160	B17	V17	35	26	38

曲柄把手 Cranked Handles

2035

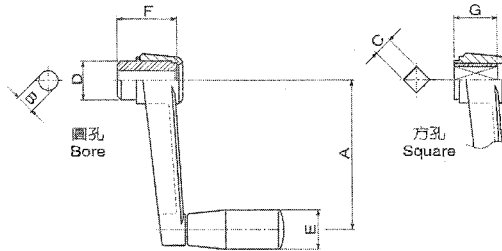
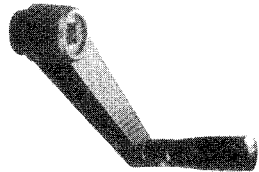

名稱 Name	材質 Material	表面處理 Surfaced process
曲柄 Cranked	尼龍加玻璃纖維 (KT)	黑色 Black (BK)
把手 Handle	鋼鐵 Steel (ST)	
軸 Spindle	電木 Bakelite (KU)	
	黑色 Black	

(mm)

Order No. 圓孔 (Bore)	Order No. 方孔 (Square)	A	B	C	D	E	F	G
2035 - 50 - B 6	2035 - 50 - V 6	50	B6	V6	16	14	28	18
- 64 - B 8	- 64 - V 8	64	B8	V8	18	18	29	19
- 64 - B10	- 64 - V10	64	B10	V10	18	18	29	19
- 80 - B10	- 80 - V10	80	B10	V10	22	21	32	22
- 100 - B12	- 100 - V12	100	B12	V12	24	23	37	27
- 130 - B14	- 130 - V14	130	B14	V14	28	26	44	30
- 160 - B16	- 160 - V17	160	B16	V17	34	26	49	34

[35]

曲柄把手 Cranked Handles

2040

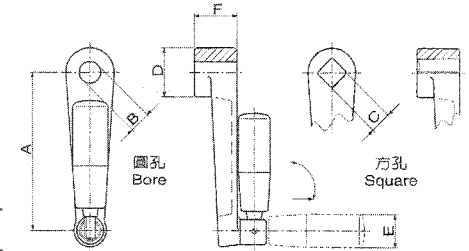
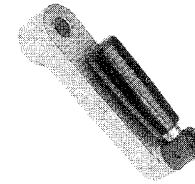

名稱 Name	材質 Material	表面處理 Surfaced process
曲柄 Cranked	鋁合金 Aluminum (AL)	電鍍黑色 Matt black (B)
把手 Handle	電木 Bakelite (KU)	鍍霧銀 Matt silver (EL)
	黑色 Black	

(mm)

Order No. 圓孔 (Bore)	Order No. 方孔 (Square)	A	B	C	D	E	F
2040 - 100 - B12	2040 - 100 - V12	100	B12	V12	27	23	28
- 125 - B14	- 125 - V14	125	B14	V14	32	26	34
- 160 - B17	- 160 - V17	160	B17	V17	35	26	38

曲柄把手 Cranked Handles

2050

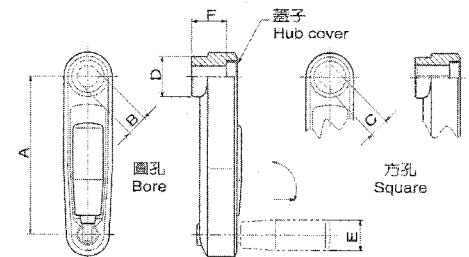
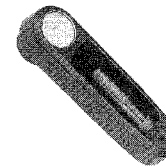

名稱 Name	材質 Material	表面處理 Surfaced process
曲柄 Cranked	鋁合金 Aluminum (AL)	電鍍黑色 Matt black (B)
把手 Handle	電木 Bakelite (KU)	鍍霧銀 Matt silver (EL)
	黑色 Black	
蓋子 Cap	塑膠 Plastic (PL)	

(mm)

Order No. 圓孔 (Bore)	Order No. 方孔 (Square)	A	B	C	D	E	F
2050 - 80 - B10	2050 - 80 - V10	80	B10	V10	23	18	20
- 100 - B12	- 100 - V12	100	B12	V12	26	22	24
- 125 - B14	- 125 - V14	125	B14	V14	28	23	31

[36]

曲柄把手

2060

Commercial Cranked Handles

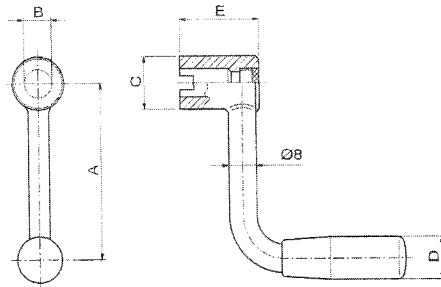
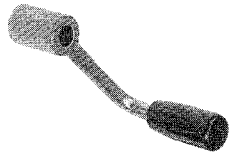

名稱 Name	材質 Material	表面處理 Surfaced process
曲柄 Cranked	鋼鐵 Steel (ST)	原色 Natural (N)
把手 Handle	椰木 Bakelite (KU)	電鍍黑色 Matt black (B)
	黑色 Black	鍍霧銀 Matt silver (EL)
		鍍亮鉻 Chrome bright (CR)

(mm)

Order No. 鋼鐵 (ST)	A	B	C	D	E
2060 - 63 - 10	63	10	18	18	28
- 80 - 10	80	10	18	18	28
- 100 - 12	100	12	21	20	30
- 125 - 12	125	12	21	20	30

三球把手

Tri-Ball Handles

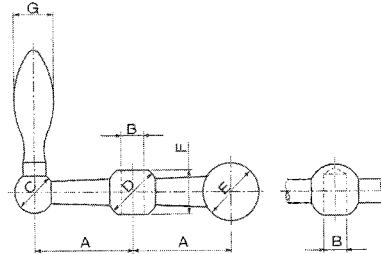
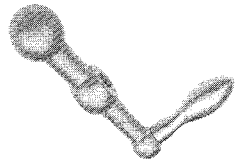

名稱 Name	材質 Material	表面處理 Surfaced process
本體 Base metal	脫臘鑄造 Precision casting	鍍亮鉻 Chrome bright (CR)
		鍍霧銀 Matt silver (EL)

(mm)

Order No. 鋼鐵 (ST)	A	B	C	D	E	F	G
2080 - 25 - 7	25	7	13	16	18	13	14
- 28 - 8	28	8	15	19	20	17	14
- 34 - 8	34	8	16	20	22	17	14
- 41 - 10	41	10	18	23	25	19.5	16
- 50 - 12	50	12	20	26	28	21.5	20
- 63 - 12	63	12	21	32	32	22	20
- 80 - 12	80	12	23	35	38	25	25

[37]

曲柄把手

2090

Cranked Handles

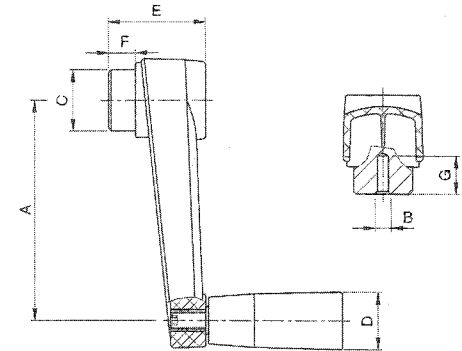
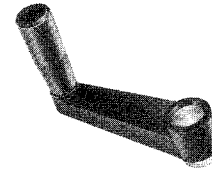

名稱 Name	材質 Material	表面處理 Surfaced process
曲柄 Cranked	尼龍加玻璃纖維 (KT)	黑色 Black
把手 Handle	尼龍加玻璃纖維 (KT)	

(mm)

Order No. 尼龍加玻璃纖維 (KT)	A	B	C	D	E	F	G
2090 - 65 - B4	65	B4	18	17 x 40	33	10	12
- 80 - B4	80	B4	22	21 x 50	36	10	12
- 100 - B4	100	B4	24	25 x 65	40	10	12
- 130 - B6	130	B6	28	28 x 85	49	14	16
- 160 - B6	160	B6	34	28 x 85	55	15	17

曲柄把手

Cranked Handles

2091

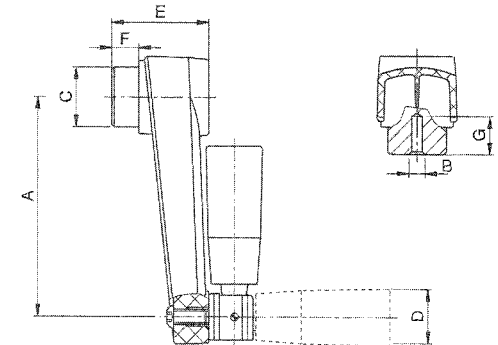
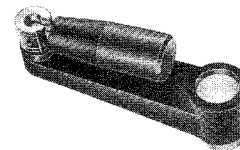

名稱 Name	材質 Material	表面處理 Surfaced process
曲柄 Cranked	尼龍加玻璃纖維 (KT)	黑色 Black
把手 Handle	尼龍加玻璃纖維 (KT)	

(mm)

Order No. 尼龍加玻璃纖維 (KT)	A	B	C	D	E	F	G
2091 - 80 - B4	80	B4	22	21 x 50	36	10	12
- 100 - B4	100	B4	24	25 x 65	40	10	12
- 130 - B6	130	B6	28	25 x 65	49	14	16
- 160 - B6	160	B6	34	28 x 85	55	15	17

[38]

曲柄把手 Cranked Handles

2095

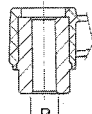
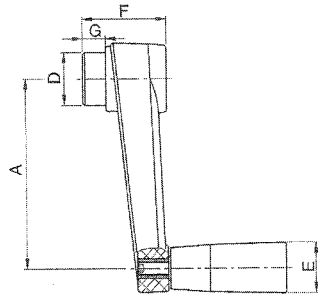
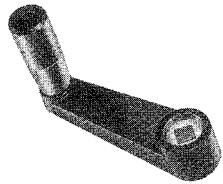

方孔 Square

圓孔 Bore

名稱 Name	材質 Material	表面處理 Surface process
曲柄 Cranked	尼龍加玻璃纖維 (KT)	黑色 Black
把手 Handle	尼龍加玻璃纖維 (KT)	

(mm)

Order No. 圓孔 (Bore)	Order No. 方孔 (Square)	A	B	C	D	E	F	G
2095 - 65 - B8	2095 - 65 - V8	65	B8	V8	18	17 x 40	33	10
- 80 - B10	- 80 - V10	80	B10	V10	22	21 x 50	36	10
- 100 - B12	- 100 - V12	100	B12	V12	24	25 x 65	40	10
- 130 - B14	- 130 - V14	130	B14	V14	28	28 x 85	49	14
- 160 - B16	- 160 - V17	160	B16	V17	34	28 x 85	55	15

曲柄把手 Cranked Handles

2096

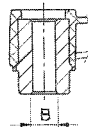
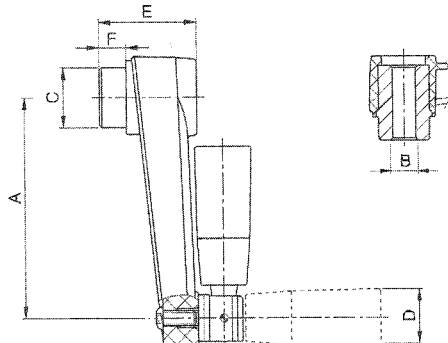
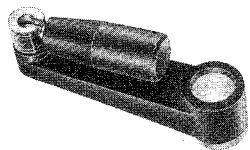

圓孔 Bore

名稱 Name	材質 Material	表面處理 Surface process
曲柄 Cranked	尼龍加玻璃纖維 (KT)	黑色 Black
把手 Handle	尼龍加玻璃纖維 (KT)	

(mm)

Order No. 尼龍加玻璃纖維 (KT)	A	B	C	D	E	F
2096 - 80 - B10	80	B10	22	21 x 50	36	10
- 100 - B12	100	B12	24	25 x 65	40	10
- 130 - B14	130	B14	28	25 x 65	49	14
- 160 - B16	160	B16	34	28 x 85	55	15

手輪 Handwheels

3010

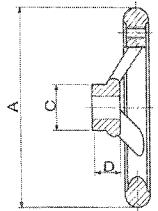
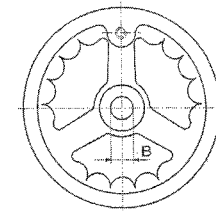
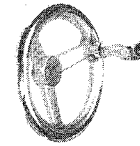

名稱 Name	材質 Material	表面處理 Surface process
手輪 Handwheel	鑄鐵 Cast iron (CI)	鍍亮鉻 Chrome bright (CR)

(mm)

Order No. 鑄鐵 (CI)	A	B	C	D
3010 - 89 - B7	89	B7	33	25
- 101 - B7	101	B7	40	29
- 127 - B7	127	B7	48	25
- 152 - B8	152	B8	50	30
- 178 - B8	178	B8	53	30
- 203 - B8	203	B8	59	31
- 254 - B8	254	B8	67	32
- 304 - B8	304	B8	70	39
- 355 - B12	355	B12	74	43
- 406 - B12	406	B12	84	47
- 457 - B12	457	B12	84	48
- 508 - B12	508	B12	84	50

二叉實心鐵手輪 Two-Spoke Full Cast Iron Handwheels

3015

NEW

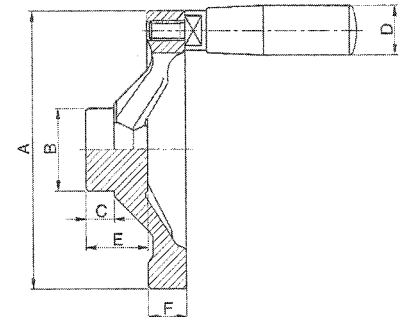
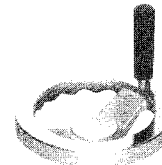

名稱 Name	材質 Material	表面處理 Surface process
手輪 Handwheel	鑄鐵 Cast iron (CI)	鍍亮鉻 Chrome bright (CR)
把手 Handle	電木 Bakelite (KU)	黑色 Black

(mm)

Order No. 鑄鐵 (CI)	A	B	C	D	E	F
3015 - 100 - B3	100	B3	10	18	22	14
- 125 - B5	125	B5	10	18	22	14
- 140 - B5	140	B5	12	18	25	15
- 160 - B5	160	B5	12	22	18	15
- 200 - B5	200	B5	16	22	34	20
- 250 - B5	250	B5	18	22	40	22

三叉實心鐵手輪 Three-Spoke Full Cast Iron Handwheels

3016

NEW

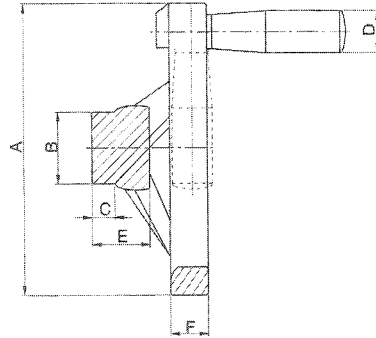
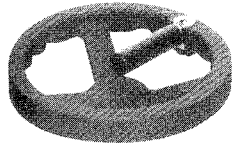

名稱 Name	材質 Material	表面處理 Surface process
手輪 Handwheel	鑄鐵 Cast iron (CI)	黑色烤漆 Paint black (BK)
把手 Handle	電木 Bakelite (KU) 黑色 Black	

(mm)

Order No. 鋁合金 (AL)	A	B	C	D	E	F
3016 - 100 - 40	100	40	15	22	32	21
- 200 - 45	200	45	15	22	35	21
- 250 - 50	250	50	15	22	40	21

碟型手輪 Disc Handwheels

3020

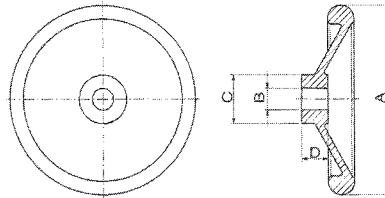

名稱 Name	材質 Material	表面處理 Surface process
手輪 Handwheel	鋁合金 Aluminum (AL)	鍍亮鉻 Chrome bright (CR) 鍍霧鉻 Matt silver (EL)

(mm)

Order No. 鋁合金 (AL)	A	B	C	D
3020 - 80 - B10	80	B10	26	16
- 100 - B10	100	B10	28	17
- 125 - B12	125	B12	31	18
- 160 - B14	160	B14	36	20
- 200 - B18	200	B18	42	24
- 250 - B22	250	B22	48	28
- 315 - B26	315	B26	56	33
- 400 - B30	400	B30	65	38

[41]

碟型手輪 Disc Handwheels

3030

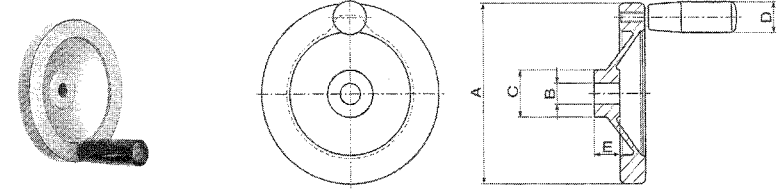

名稱 Name	材質 Material	表面處理 Surface process
手輪 Handwheel	鋁合金 Aluminum (AL)	鍍亮鉻 Chrome bright (CR)
把手 Handle	電木 Bakelite (KU) 黑色 Black	鍍霧鉻 Matt silver (EL) 黑色烤漆 Paint black (BK)

(mm)

Order No. 鋁合金 (AL)	A	B	C	D	E
3030 - 80 - B10	80	B10	28	18	21
- 100 - B10	100	B10	28	21	17
- 125 - B12	125	B12	31	23	21
- 140 - B14	140	B14	36	23	19
- 160 - B14	160	B14	42	26	26
- 200 - B18	200	B18	42	28	38
- 250 - B22	250	B22	48	28	48

電木碟型手輪 Bakelite Disc Handwheels

3041

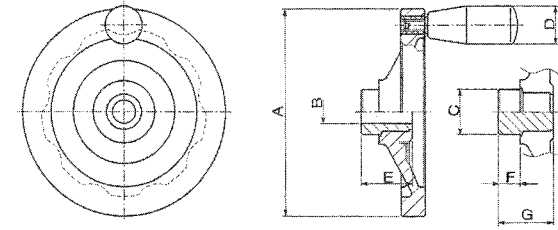

名稱 Name	材質 Material
手輪 Handwheel	電木 Bakelite (KU)
軸 Spindle	鋼鐵 Steel (ST)
把手 Handle	電木 Bakelite (KU) 黑色 Black

圓孔
Bore

實心
Full

(mm)

Order No. 鋼 (ST)	Order No. 鋁 (AL)	A	B	C	D	E	F	G
3041 - 100 - B12	3041 - 100 - 28	100	B12	28	21	16	15	57
- 125 - B12	- 125 - 32	125	B12	32	23	16	15	40
- 160 - B16	- 160 - 36	160	B16	36	26	30	15	40
- 180 - B18	- 180 - 36	180	B18	36	26	30	15	40
- 200 - B18	- 200 - 40	200	B18	40	28	25	15	43
- 250 - B22	- 250 - 40	250	B22	40	28	25	15	43

[42]

手輪 Handwheels

3050

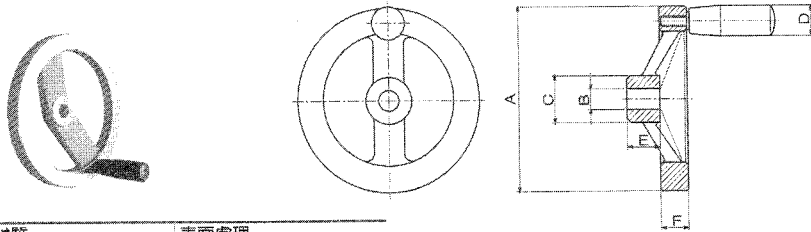

名稱 Name	材質 Material	表面處理 Surfaced process
手輪 Handwheel	鋁合金 Aluminum (AL)	鍍亮鎳 Chrome bright (CR)
把手 Handle	電木 Bakelite (KU)	鍍霧銀 Matt silver (EL)
	黑色 Black	黑色烤漆 Paint black (BK)

(mm)

Order No. 鋁合金 (AL)	A	B	C	D	E	F
3050 - 125 - B12	125	B12	31	23	18	15
- 140 - B14	140	B14	36	23	19	16.5
- 160 - B14	160	B14	36	26	20	18
- 200 - B18	200	B18	42	28	24	20.5
- 250 - B22	250	B22	48	28	28	23

二叉塑膠手輪 Two-Spoke Plastic Handwheels

3055

NEW

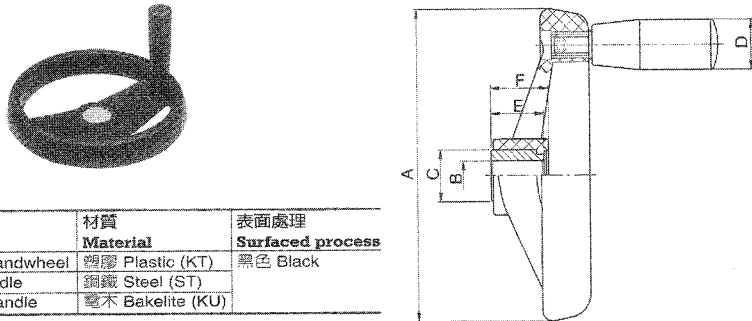

名稱 Name	材質 Material	表面處理 Surfaced process
手輪 Handwheel	塑膠 Plastic (KT)	黑色 Black
軸 Spindle	鋼鐵 Steel (ST)	
把手 Handle	電木 Bakelite (KU)	

(mm)

Order No. 塑膠 (KT)	A	B	C	D	E	F
3055 - 80 - B10	80	B10	18	18	17	19
- 100 - B10	100	B10	18	21	17	19
- 125 - B12	125	B12	22	23	22	25
- 160 - B14	160	B14	26	26	27	29
- 200 - B16	200	B16	30	28	34	36
- 250 - B20	250	B20	35	28	38	40
- 300 - B20	300	B20	40	31	43	46
- 375 - B26	375	B26	40	31	43	46

[43]

二叉塑膠手輪 Two-Spoke Plastic Handwheels

3056

NEW

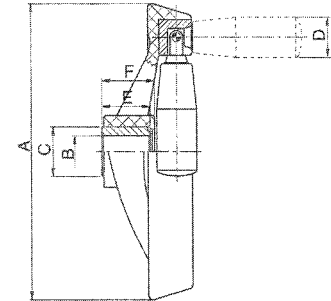

名稱 Name	材質 Material	表面處理 Surfaced
手輪 Handwheel	塑膠 Plastic (KT)	黑色 Black
軸 Spindle	鋼鐵 Steel (ST)	
把手 Handle	電木 Bakelite (KU)	

(mm)

Order No. 塑膠 (KT)	A	B	C	D	E	F
3056 - 80 - B10	80	B10	18	18	17	19
- 100 - B10	100	B10	18	21	17	19
- 125 - B12	125	B12	22	23	22	25
- 160 - B14	160	B14	26	26	27	29
- 200 - B16	200	B16	30	28	34	36
- 250 - B20	250	B20	35	28	38	40
- 300 - B20	300	B20	40	31	43	46
- 375 - B26	375	B26	40	31	43	46

鋁手輪 Aluminum Handwheels

3061

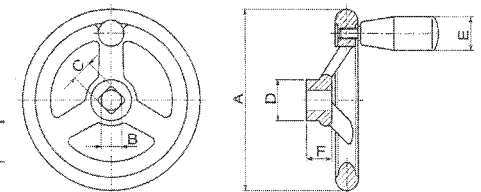

名稱 Name	材質 Material	表面處理 Surfaced
手輪 Handwheel	鋁合金 Aluminum (AL)	黑色烤漆
把手 Handle	電木 Bakelite (KU)	黑色 Black

(mm)

Order No. 圓孔 (Bore)	Order No. 方孔 (Square)	A	B	C	D	E	F
3061 - 80 - B10	3061 - 80 - V9	80	B10	V9	24	18	16
- 100 - B10	- 100 - V9	100	B10	V9	26	21	17
- 125 - B12	- 125 - V11	125	B12	V11	28	23	18
- 140 - B14		140	B14		30	23	19
- 160 - B14	- 160 - V12	160	B14	V12	33	26	20
- 180 - B16		180	B16		58	26	26.5
- 200 - B18	- 200 - V14	200	B18	V14	38	28	24
- 250 - B22	- 250 - V17	250	B22	V17	45	28	28
- 315 - B26	- 315 - V19	315	B26	V19	53	28	33
- 400 - B30	- 400 - V24	400	B30	V24	65	31	38
- 500 - B34	- 500 - V27	500	B34	V27	78	31	45

[44]

塑膠手輪
Plastic Handwheels

3070

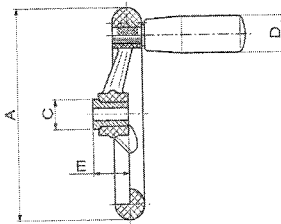
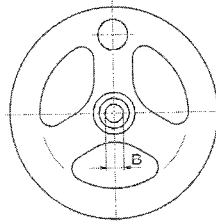

名稱	材質
Name	Material
手輪 Handwheel	塑膠 Plastic (KT)
把手 Handle	塑膠 Plastic (KT)

(mm)

Order No. 型號 (KT)	A	B	C	D	E
3070 - 100 - B10	100	B10	24	21	22
- 125 - B12	125	B12	24	23	25
- 140 - B14	140	B14	32	23	26
- 160 - B14	160	B14	32	26	28
- 200 - B18	200	B18	40	28	32
- 250 - B22	250	B22	49	28	36
- 300 - B26	300	B26	58	28	40

塑膠手輪
Plastic Handwheels

3071

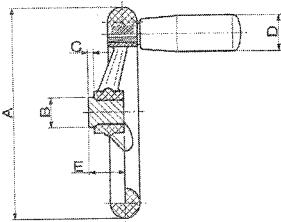
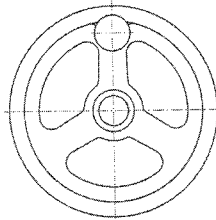

名稱	材質
Name	Material
手輪 Handwheel	塑膠 Plastic (KT)
把手 Handle	塑膠 Plastic (KT)

(mm)

Order No. 型號 (KT)	A	B	C	D	E
3071 - 80 - 18	80	18	8	18	25
- 100 - 20	100	20	10	21	26
- 125 - 28	125	28	15	23	33
- 140 - 32	140	32	15	23	33
- 160 - 36	160	36	15	26	37
- 200 - 40	200	40	15	28	39

[45]

電木三叉手輪
Bakelite Three-Spoke Handwheels

3072

NEW

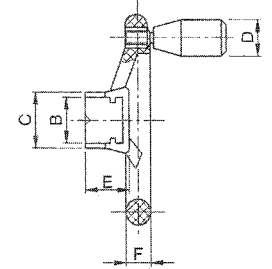
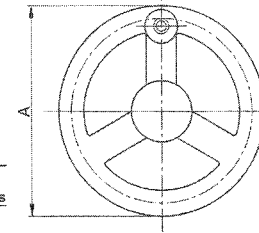
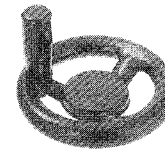

名稱	材質	表面處理
Name	Material	Surface process
手輪 Handwheel	電木 Bakelite (KU)	黑色 Black
把手 Handle	電木 Bakelite (KU)	

(mm)

Order No. 型號 (KU)	A	B	C	D	E	F
3072 - 80 - 20	80	20	28	20	25	13
- 100 - 25	100	25	35	20	28	13
- 125 - 30	125	30	40	20	30	17
- 140 - 30	140	30	45	23	30	18
- 160 - 30	160	30	45	23	35	20
- 180 - 35	180	35	50	23	35	23
- 200 - 35	200	35	50	24	40	23

電木三叉手輪
Bakelite Three-Spoke Handwheels

3075

NEW

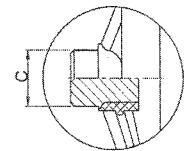
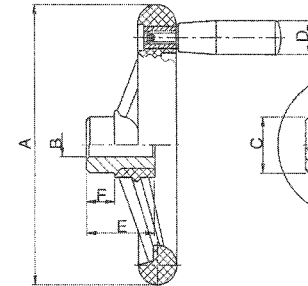
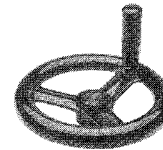

名稱	材質	表面處理
Name	Material	Surface process
手輪 Handwheel	電木 Bakelite (KU)	黑色 Black
軸 Spindle	鋼鐵 Steel (ST)	
把手 Handle	電木 Bakelite (KU)	黑色 Black

3075-圓孔 Bore

3076-實心 Full

(mm)

Order No. 圓孔 (Bore)	Order No. 實心 (Full)	A	B	C	D	E	F
3075 - 100 - B16	3076 - 100 - 24	100	B16	24	18	36	12
- 125 - B16	- 125 - 24	125	B16	24	21	36	12
- 140 - B20	- 140 - 32	140	B20	32	23	38	15
- 160 - B20	- 160 - 32	160	B20	32	23	38	15
- 180 - B26	- 180 - 40	180	B26	40	26	43	15
- 200 - B26	- 200 - 40	200	B26	40	26	43	15
- 250 - B34	- 250 - 49	250	B34	49	28	44	15
- 290 - B42	- 290 - 58	290	B42	58	31	56	18
- 375 - B45	- 375 - 58	375	B45	58	31	77	26

[46]

控制旋鈕 Control Knobs

3080

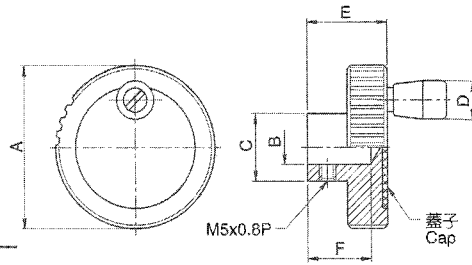
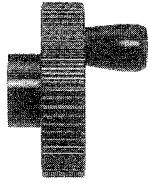

名稱 Name	材質 Material	表面處理 Surfaced process
旋鈕 Knob	鋁合金 Aluminum (AL)	電鍍黑色 Matt black (B)
把手 Handle	塑膠 Plastic (KT)	黑色 Black
蓋子 Cap	鋁合金蓋子 Aluminum cap	

(mm)

Order No. 型號 (ALL)	A	B	C	D	E	F
3080 - 42 - B10	42	B10	20	14	23	15
- 52 - B10	52	B10	22	14	23	15
- 62 - B10	62	B10	25	14	23	15
- 72 - B10	72	B10	28	14	23	15

控制旋鈕 Control Knobs

3090

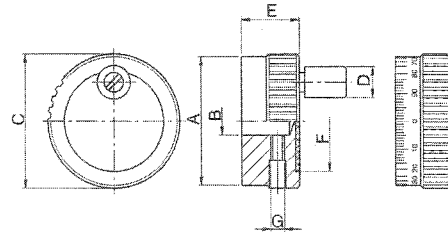
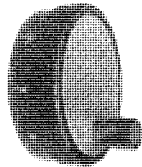

名稱 Name	材質 Material	表面處理 Surfaced process
旋鈕 Knob	鋁合金 Aluminum (AL)	電鍍黑色 Matt black (B)
把手 Handle	塑膠 Plastic (KT)	黑色 Black
蓋子 Cap	鋁合金蓋子 Aluminum cap	

3090 Type A	3091 Type B	3092 Type C	3093 Type D
無把手無刻度 Without handle and scale	有把手 With handle	有刻度 With scale	有把手有刻度 With handle and scale

(mm)

Order No. Type A	Order No. Type B	Order No. Type C	Order No. Type D	A	B	C	D	E	F	G
3090 - 50 - B10	3091 - 50 - B10	3092 - 50 - B10	3093 - 50 - B10	50	B10	52	14	23	39.1	M5
- 60 - B10	- 60 - B10	- 60 - B10	- 60 - B10	60	B10	62	14	23	51.7	M5
- 70 - B10	- 70 - B10	- 70 - B10	- 70 - B10	70	B10	72	14	23	65.1	M5

[47]

滾花手輪 Knurled Handwheels

3100

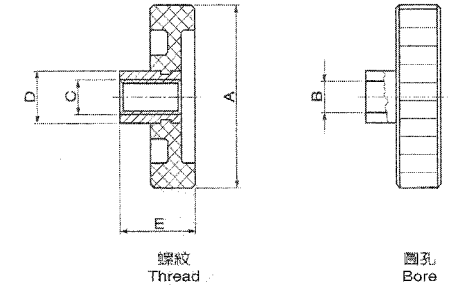

名稱 Name	材質 Material	表面處理 Surfaced process
手輪 Handwheel	塑膠 Plastic (KT)	黑色 Black
軸 Spindle	鋼 Steel	鍍鋅 Zincing (ZI)

(mm)

Order No. 螺紋 (Thread)	Order No. 圓孔 (Bore)	A	B	C	D	E
3100 - 50 - M10	3100 - 50 - B10	50	B10	M10	18	25
- 63 - M12	- 63 - B12	63	B12	M12	20	30
- 80 - M16	- 80 - B16	80	B16	M16	25	36

鋁手輪 Aluminum Handwheels

3120

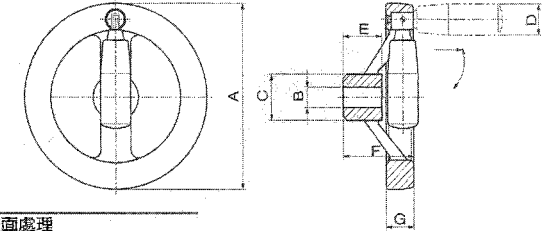

名稱 Name	材質 Material	表面處理 Surfaced process
把手 Handle	電木 Bakelite (KU) 黑色 Black	鍍亮鉻 Chrome bright (CR) 鍍霧銀 Matt silver (EL)
手輪 Handwheel	鋁合金 Aluminum (AL)	黑色烤漆 Paint black (BK)
折疊結構 Retractable mechanism	鋼鐵 Steel (ST) 電鍍黑色 Matt black (B)	

(mm)

Order No. 鋁合金 (AL)	A	B	C	D	E	F	G
3120 - 125 - B12	125	B12	31	23	26	51.3	24.5
- 140 - B14	140	B14	36	23	19	45.5	24.5
- 160 - B14	160	B14	36	26	20	47	26
- 200 - B18	200	B18	42	26	24	52.5	26
- 250 - B22	250	B22	59	28	30	57	28

[48]

碗型鋁手輪 Solid Aluminum Handwheels

3130

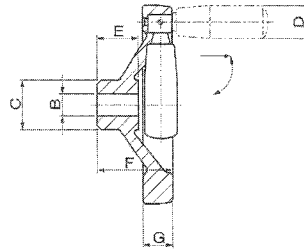
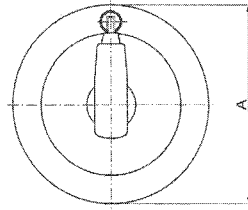

名稱 Name	材質 Material	表面處理 Surfaced process
把手 Handle	電木 Bakelite (KU) 黑色 Black	鍍亮鉻 Chrome bright (CR) 鍍霧銀 Matt silver (EL)
手輪 Handwheel	鋁合金 Aluminum (AL)	黑色烤漆 Paint black (BK)
折疊結構 Retractable mechanism	鋼鐵 Steel (ST)	電鍍黑色 Matt black (B)

(mm)

Order No. 圓孔 (Bore)	A	B	C	D	E	F	G
3130 - 125 - B12	125	B12	31	23	18	44	24.5
- 200 - B16	200	B16	32	25	20	57	28

碗型手輪 Solid Handwheels

3131

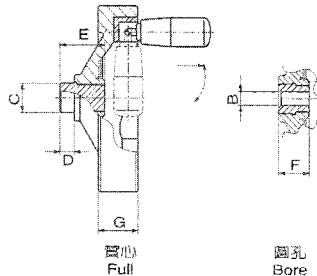
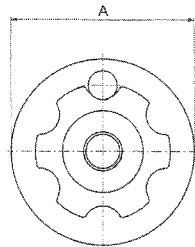

名稱 Name	材質 Material	表面處理 Surfaced process
把手 Handle	電木 Bakelite (KU)	黑色 Black
軸 Spindle	鋼鐵 Steel (ST)	

(mm)

Order No. 圓孔 (Bore)	Order No. 圓孔 (Full)	A	B	C	D	E	F	G
3131 - 100 - B12	3132 - 100 - 28	100	B12	28	15	37	22	26
- 125 - B12	- 125 - 32	125	B12	32	15	39	24	30
- 160 - B16	- 160 - 36	160	B16	36	15	40	25	32
- 200 - B18	- 200 - 40	200	B18	40	15	44	29	34
- 250 - B22	-	250	B22	-	15	-	33	36

[49]

沖壓成型鋼鐵手輪 Pressed Steel Handwheels

3150

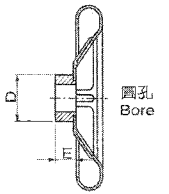
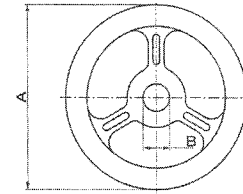

名稱 Name	材質 Material	表面處理 Surfaced process
手輪 Handwheel	鋼鐵 Steel (ST)	鍍亮鉻 Chrome bright (CR) 鍍霧銀 Matt silver (EL) 黑色烤漆 Paint black (BK)

(mm)

Order No. 圓孔 (Bore)	Order No. 方孔 (Square)	A	B	C	D	E
3150 - 125 - B11	3150 - 125 - V11	125	B11	V11	30	18
- 160 - B12	- 160 - V12	160	B12	V12	30	20
- 200 - B14	- 200 - V14	200	B14	V14	40	24
- 250 - B17	- 250 - V17	250	B17	V17	45	28
- 315 - B19	- 315 - V19	315	B19	V19	55	33
- 400 - B24	- 400 - V24	400	B24	V24	65	38

沖壓成型不銹鋼手輪 Pressed ST. Steel Handwheels

3160

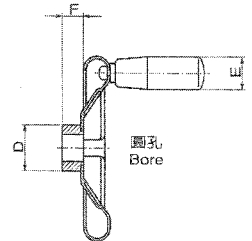
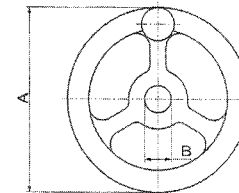
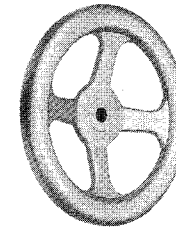

名稱 Name	材質 Material
把手 Handle	電木 Bakelite (KU) 黑色 Black
軸 Spindle	不銹鋼 Stainless steel (SST)
手輪 Handwheel	不銹鋼 Stainless steel (SST)

(mm)

Order No. 圓孔 (Bore)	Order No. 方孔 (Square)	A	B	C	D	E	F
3160 - 160 - B12	3160 - 160 - V12	160	B12	V12	30	26	20
- 200 - B14	- 200 - V14	200	B14	V14	40	26	24
- 250 - B17	- 250 - V17	250	B17	V17	45	28	28

[50]

二又不銹鋼手輪
ST. Steel Offset Handwheels

3170

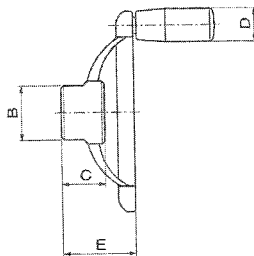
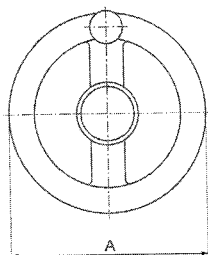

名稱 Name	材質 Material	表面處理 Surfaced process
手輪 Handwheel	不銹鋼 Stainless steel (SST)	
把手 Handle	電木 Bakelite (KU)	黑色 Black

(mm)

Order No. 不銹鋼 (SST)	A	B	C	D	E
3170 - 80 - 26	80	26	17	18	28
- 100 - 26	100	26	18	18	30
- 125 - 32	125	32	20	21	34
- 140 - 34	140	34	22	21	38
- 160 - 36	160	36	24	23	42
- 200 - 42	200	42	24	28	42
- 250 - 50	250	50	34	28	53

電木三幅手輪
Bakelite Three Spoked Handwheels

3180

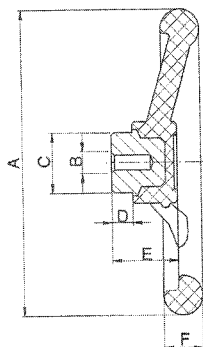
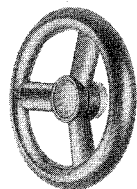

名稱 Name	材質 Material	表面處理 Surfaced process
手輪 Handwheel	電木 Bakelite (KU)	黑色 Black
軸 Spindle	鋼鐵 Steel (ST)	

(mm)

Order No. 電木 (KU)	A	B	C	D	E	F
3180 - 100 - B 4	100	B4	24	11	34	15
- 125 - B 6	125	B6	24	13	37	17
- 150 - B 8	150	B8	32	13	38	20
- 175 - B 8	175	B8	40	16	42	22
- 200 - B 8	200	B8	40	16	45	24
- 250 - B10	250	B10	48	17	50	28
- 300 - B10	300	B10	58	18	56	34

[51]

電木三幅手輪
Bakelite Three Spoked Handwheels

3181

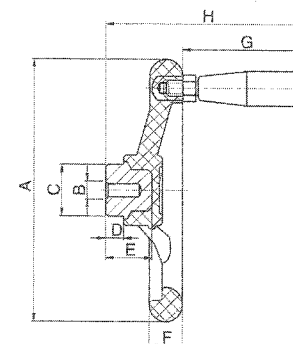
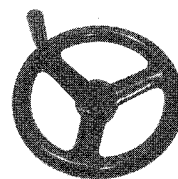

名稱 Name	材質 Material	表面處理 Surfaced process
手輪 Handwheel	電木 Bakelite (KU)	黑色 Black
軸 Spindle	鋼鐵 Steel (ST)	
把手 Handle	電木 Bakelite (KU)	

(mm)

Order No. 電木 (KU)	A	B	C	D	E	F	G	H
3181 - 100 - B 4	100	B4	24	11	34	15	17 x 40	85
- 125 - B 6	125	B6	24	13	37	17	23 x 55	107
- 150 - B 8	150	B8	32	13	38	20	25 x 65	120
- 175 - B 8	175	B8	40	16	42	22	25 x 65	127
- 200 - B 8	200	B8	40	16	45	24	28 x 85	153
- 250 - B10	250	B10	48	17	50	28	28 x 85	164
- 300 - B10	300	B10	58	18	56	34	28 x 85	170

電木三幅手輪
Bakelite Three Spoked Handwheels

3182

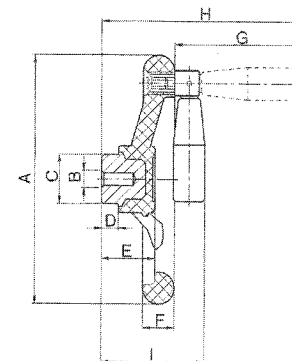
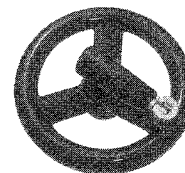

名稱 Name	材質 Material	表面處理 Surfaced process
手輪 Handwheel	電木 Bakelite (KU)	黑色 Black
軸 Spindle	鋼鐵 Steel (ST)	
把手 Handle	電木 Bakelite (KU)	
折疊結構 Retractable mechanism	電木 Bakelite (KU)	

(mm)

Order No. 電木 (KU)	A	B	C	D	E	F	G	H	I
3182 - 125 - B 6	125	B6	24	13	37	17	23 x 55	118	66
- 150 - B 8	150	B8	32	13	38	20	25 x 65	131	70
- 175 - B 8	175	B8	40	16	42	22	25 x 65	138	77
- 200 - B 8	200	B8	40	16	45	24	28 x 85	166	85
- 250 - B10	250	B10	48	17	50	28	28 x 85	177	96
- 300 - B10	300	B10	58	18	56	34	28 x 85	183	102

[52]

電木三幅手輪
Bakelite Three Spoked Handwheels

3190

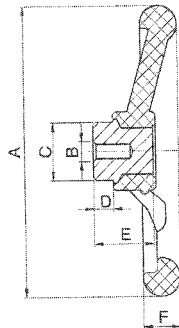
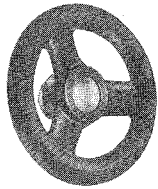

名稱	材質
Name	Material
手輪 Handwheel	電木 Bakelite (KU)
軸 Spindle	鋼鐵 Steel (ST)

(mm)

Order No. 電木 (KU)	A	B	C	D	E	F
3190 - 100 - B4	100	B4	24	11	33	15
- 125 - B6	125	B6	24	13	36	17
- 150 - B6	150	B6	32	13	37	20
- 175 - B6	175	B6	40	16	41	22
- 200 - B6	200	B6	40	16	44	24
- 250 - B6	250	B6	48	17	49	28
- 300 - B6	300	B6	58	18	54	34

電木三幅手輪
Bakelite Three Spoked Handwheels

3191

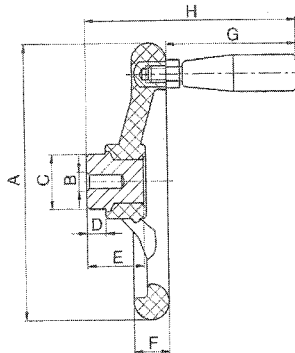

名稱	材質	表面處理
Name	Material	Surfaced process
手輪 Handwheel	電木 Bakelite (KU)	黑色 Black
軸 Spindle	鋼鐵 Steel (ST)	
把手 Handle	電木 Bakelite (KU)	黑色 Black

(mm)

Order No. 電木 (KU)	A	B	C	D	E	F	G	H
3191 - 100 - B4	100	B4	24	11	33	15	17 x 40	85
- 125 - B6	125	B6	24	13	36	17	23 x 55	107
- 150 - B6	150	B6	32	13	37	20	25 x 65	120
- 175 - B6	175	B6	40	16	41	22	25 x 65	127
- 200 - B6	200	B6	40	16	44	24	28 x 85	153
- 250 - B6	250	B6	48	17	49	28	28 x 85	164
- 300 - B6	300	B6	58	18	54	34	28 x 85	170

[53]

電木三幅手輪
Bakelite Three Spoked Handwheels

3192

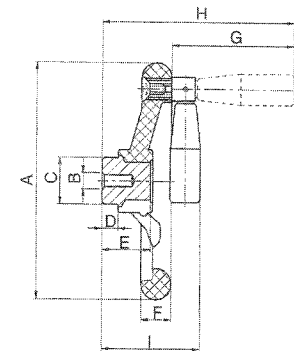

名稱	材質	表面處理
Name	Material	Surfaced process
手輪 Handwheel	電木 Bakelite (KU)	黑色 Black
軸 Spindle	鋼鐵 Steel (ST)	
把手 Handle	電木 Bakelite (KU)	
折疊結構 Retractable mechanism	電木 Bakelite (KU)	

(mm)

Order No. 電木 (KU)	A	B	C	D	E	F	G	H	I
3192 - 125 - B6	125	B6	24	13	36	17	23 x 55	118	66
- 150 - B6	150	B6	32	13	37	20	25 x 65	131	70
- 175 - B6	175	B6	40	16	41	22	25 x 65	138	77
- 200 - B6	200	B6	40	16	44	24	28 x 85	166	85
- 250 - B6	250	B6	48	17	49	28	28 x 85	177	96
- 300 - B6	300	B6	58	18	54	34	28 x 85	183	102

電木二叉手輪
Bakelite Two Spoked Handwheels

3200

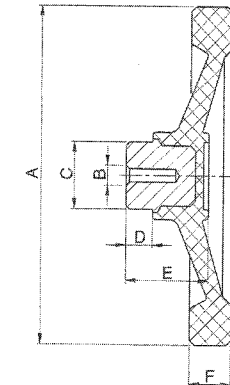
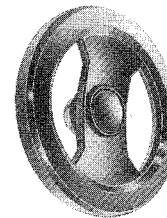

名稱	材質
Name	Material
手輪 Handwheel	電木 Bakelite (KU)
軸 Spindle	鋼鐵 Steel (ST)

(mm)

Order No. 電木 (KU)	A	B	C	D	E	F
3200 - 100 - B4	100	B4	24	11	30	14
- 125 - B4	125	B4	24	11	34	16
- 150 - B6	150	B6	32	13	38	20
- 200 - B6	200	B6	40	16	45	25
- 250 - B8	250	B8	48	17	50	28

[54]

電木二又手輪
Bakelite Two Spoked Handwheels

3201

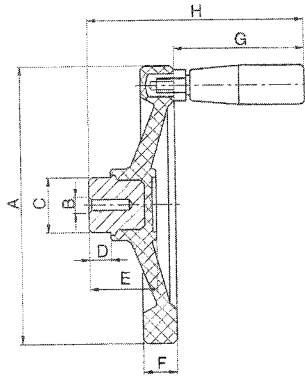
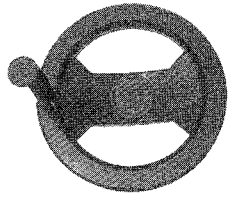

名稱 Name	材質 Material	表面處理 Surfaced process
手輪 Handwheel	電木 Bakelite (KU)	黑色 Black
軸 Spindle	鋼鐵 Steel (ST)	
把手 Handle	電木 Bakelite (KU)	

(mm)

Order No. 電木 (KU)	A	B	C	D	E	F	G	H
3201 - 100 - B4	100	B4	24	11	30	14	17 x 40	81
- 125 - B4	125	B4	24	11	34	16	23 x 55	102
- 150 - B6	150	B6	32	13	38	20	25 x 65	117
- 200 - B6	200	B6	40	16	45	25	25 x 65	154
- 250 - B8	250	B8	48	17	50	28	28 x 85	162

電木二又手輪
Bakelite Two Spoked Handwheels

3202

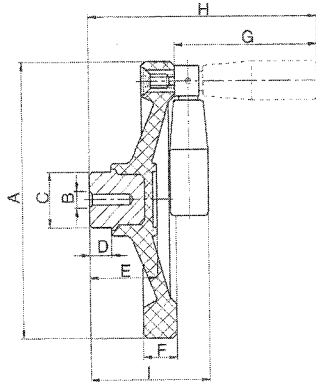
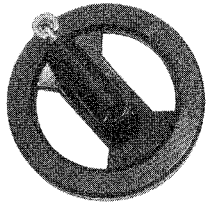

名稱 Name	材質 Material	表面處理 Surfaced process
手輪 Handwheel	電木 Bakelite (KU)	黑色 Black
軸 Spindle	鋼鐵 Steel (ST)	
把手 Handle	電木 Bakelite (KU)	
折疊結構 Retractable mechanism	電木 Bakelite (KU)	

(mm)

Order No. 電木 (KU)	A	B	C	D	E	F	G	H
3202 - 125 - B4	125	B4	24	11	34	16	23 x 55	112
- 150 - B6	150	B6	32	13	38	20	25 x 65	127
- 200 - B6	175	B6	40	16	45	25	25 x 65	167
- 250 - B8	200	B8	48	17	50	28	28 x 85	174

電木二又手輪
Bakelite Two Spoked Handwheels

3210

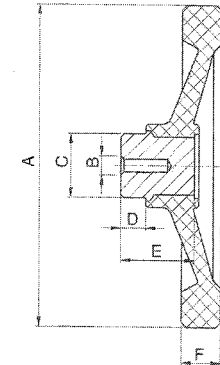
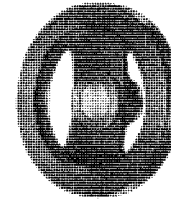

名稱 Name	材質 Material
手輪 Handwheel	電木 Bakelite (KU)
軸 Spindle	鋼鐵 Steel (ST)

(mm)

Order No. 電木 (KU)	A	B	C	D	E	F
3210 - 100 - B4	100	B4	24	11	29	14
- 125 - B4	125	B4	24	11	33	16
- 150 - B6	150	B6	32	13	37	20
- 200 - B6	200	B6	40	16	44	25
- 250 - B6	250	B6	48	17	49	28

電木二又手輪
Bakelite Two Spoked Handwheels

3211

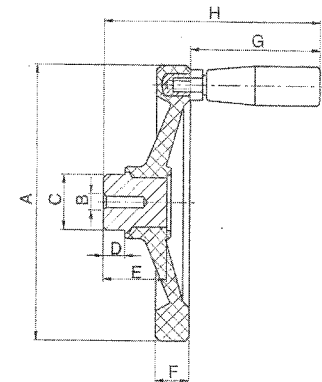
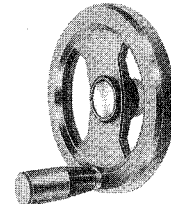

名稱 Name	材質 Material	表面處理 Surfaced process
手輪 Handwheel	電木 Bakelite (KU)	黑色 Black
軸 Spindle	鋼鐵 Steel (ST)	
把手 Handle	電木 Bakelite (KU)	黑色 Black

(mm)

Order No. 電木 (KU)	A	B	C	D	E	F	G	H
3211 - 100 - B4	100	B4	24	11	29	14	17 x 40	81
- 125 - B4	125	B4	24	11	33	16	23 x 55	102
- 150 - B6	150	B6	32	13	37	20	25 x 65	117
- 200 - B6	200	B6	40	16	44	25	25 x 65	154
- 250 - B6	250	B6	48	17	49	28	28 x 85	162

電木二叉手輪

Bakelite Two Spoked Handwheels

3212

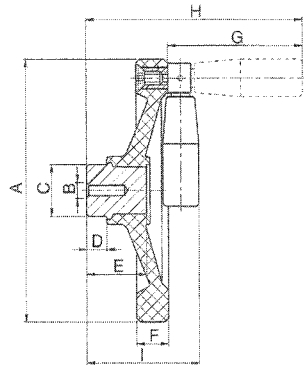

名稱 Name	材質 Material	表面處理 Surfaced process
手輪 Handwheel	電木 Bakelite (KU)	黑色 Black
軸 Spindle	鋼鐵 Steel (ST)	
把手 Handwheel	電木 Bakelite (KU)	黑色 Black
折疊結構 Retractable mechanism	電木 Bakelite (KU)	黑色 Black

(mm)

Order No. 電木 (KU)	A	B	C	D	E	F	G	H	I
3212 - 125 - B4	125	B4	24	11	33	16	23 x 65	112	61
- 150 - B6	150	B6	32	13	37	18	25 x 65	122	67
- 200 - B8	200	B8	40	15	44	22	25 x 65	147	82
- 250 - B10	250	B10	48	17	49	25	25 x 65	172	97

電木碟型手輪

Bakelite Disc Handwheels

3220

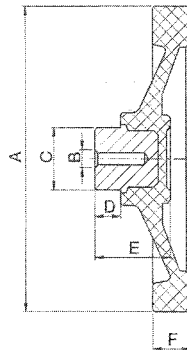
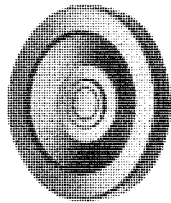

名稱 Name	材質 Material
手輪 Handwheel	電木 Bakelite (KU)
軸 Spindle	鋼鐵 Steel (ST)

(mm)

Order No. 電木 (KU)	A	B	C	D	E	F
3220 - 100 - B4	100	B4	24	11	30	14
- 125 - B6	125	B6	32	13	36	16
- 150 - B8	150	B8	32	13	38	18
- 200 - B8	200	B8	40	16	45	21
- 250 - B10	250	B10	48	17	50	22
- 300 - B10	300	B10	58	18	57	24

電木碟型手輪

Bakelite Disc Handwheels

3221

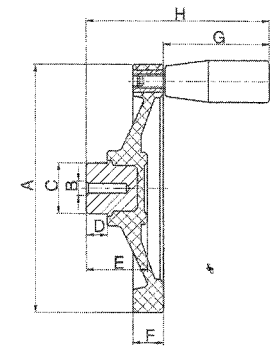
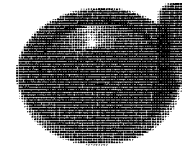

名稱 Name	材質 Material	表面處理 Surfaced process
手輪 Handwheel	電木 Bakelite (KU)	黑色 Black
軸 Spindle	鋼鐵 Steel (ST)	
把手 Handle	電木 Bakelite (KU)	

(mm)

Order No. 電木 (KU)	A	B	C	D	E	F	G	H
3221 - 100 - B4	100	B4	24	11	30	14	21 x 50	88
- 125 - B6	125	B6	32	13	36	16	23 x 50	92
- 150 - B8	150	B8	32	13	38	18	23 x 50	113
- 200 - B8	200	B8	40	16	45	21	23 x 50	145
- 250 - B10	250	B10	48	17	50	22	23 x 50	151
- 300 - B10	300	B10	58	18	57	24	23 x 50	161

電木碟型手輪

Bakelite Disc Handwheels

3222

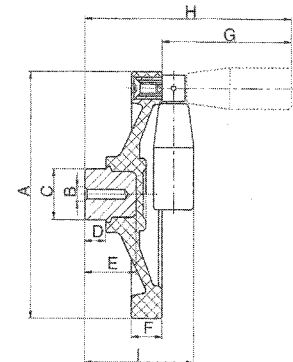
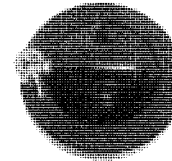

名稱 Name	材質 Material	表面處理 Surfaced process
手輪 Handwheel	電木 Bakelite (KU)	黑色 Black
軸 Spindle	鋼鐵 Steel (ST)	
把手 Handle	電木 Bakelite (KU)	
折疊結構 Retractable mechanism	電木 Bakelite (KU)	

(mm)

Order No. 電木 (KU)	A	B	C	D	E	F	G	H
3222 - 100 - B4	100	B4	24	11	30	14	21 x 50	88
- 125 - B6	125	B6	32	13	36	16	23 x 50	92
- 150 - B8	150	B8	32	13	38	18	23 x 50	100
- 200 - B8	200	B8	40	16	45	21	23 x 50	108
- 250 - B10	250	B10	48	17	50	22	23 x 50	116
- 300 - B10	300	B10	58	18	57	24	23 x 50	124

電木碟型手輪
Bakelite Disc Handwheels

3230

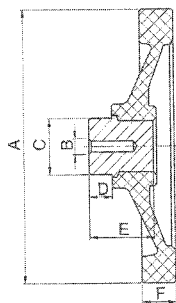
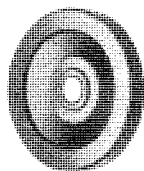

名稱 Name	材質 Material
手輪 Handwheel	電木 Bakelite (KU)
軸 Spindle	鋼鐵 Steel (ST)

(mm)

Order No. 電木 (KU)	A	B	C	D	E	F
3230 - 50 - B4	50	B4	16	9	20	11
- 65 - B4	65	B4	20	10	24	13
- 80 - B4	80	B4	20	10	27	14
- 100 - B4	100	B4	24	11	29	14
- 125 - B6	125	B6	32	13	35	16
- 150 - B6	150	B6	32	13	37	18
- 200 - B6	200	B6	40	16	44	21
- 250 - B6	250	B6	48	17	49	22
- 300 - B6	300	B6	58	18	55	24

電木碟型手輪
Bakelite Disc Handwheels

3231

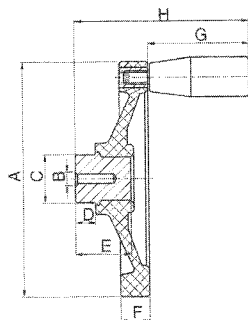
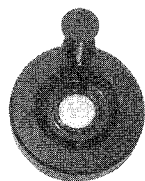

名稱 Name	材質 Material	表面處理 Surfaced process
手輪 Handwheel	電木 Bakelite (KU)	黑色 Black
軸 Spindle	鋼鐵 Steel (ST)	
把手 Handle	電木 Bakelite (KU)	黑色 Black

(mm)

Order No. 電木 (KU)	A	B	C	D	E	F	G	H
3231 - 50 - B4	50	B4	16	9	20	11	13 x 27	50
- 65 - B4	65	B4	20	10	24	13	13 x 27	55
- 80 - B4	80	B4	20	10	27	14	17 x 40	71
- 100 - B4	100	B4	24	11	29	14	21 x 50	85
- 125 - B6	125	B6	32	13	35	16	23 x 55	99
- 150 - B6	150	B6	32	13	37	18	25 x 65	113
- 200 - B6	200	B6	40	16	44	21	28 x 85	143
- 250 - B6	250	B6	48	17	49	22	28 x 85	151
- 300 - B6	300	B6	58	18	55	24	28 x 85	161

電木碟型手輪
Bakelite Disc Handwheels

3232

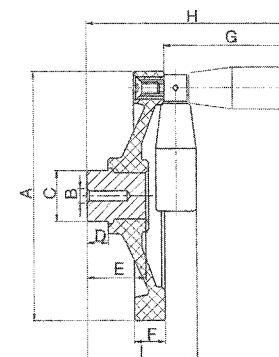
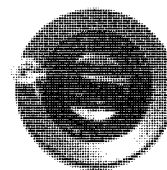

名稱 Name	材質 Material	表面處理 Surfaced process
手輪 Handwheel	電木 Bakelite (KU)	黑色 Black
軸 Spindle	鋼鐵 Steel (ST)	
把手 Handle	電木 Bakelite (KU)	
折疊結構 Retractable mechanism	電木 Bakelite (KU)	

(mm)

Order No. 電木 (KU)	A	B	C	D	E	F	G	H	I
3232 - 100 - B4	100	B4	24	11	29	14	21 x 50	102	54
- 150 - B6	150	B6	32	13	35	16	23 x 65	116	64
- 150 - B6	150	B6	32	13	37	18	25 x 65	130	68
- 200 - B6	200	B6	40	16	44	21	28 x 85	144	78
- 250 - B6	250	B6	48	17	49	22	28 x 85	173	90
- 300 - B6	300	B6	58	18	55	24	28 x 85	187	100

碗型塑膠手輪
Solid Plastic Handwheels

3500

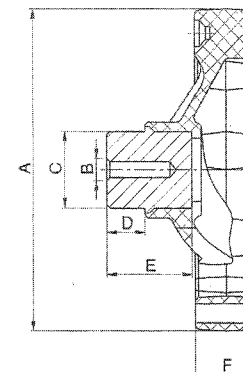
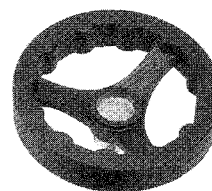

名稱 Name	材質 Material
手輪 Handwheel	尼龍加玻璃纖維 (KT)
軸 Spindle	鋼鐵 Steel (ST)

(mm)

Order No. 尼龍加玻璃纖維 (KT)	A	B	C	D	E	F
3500 - 100 - B4	100	B4	24	11	29	20
- 150 - B6	150	B6	32	13	35	24
- 150 - B6	150	B6	32	13	37	28
- 200 - B6	200	B6	40	16	44	32

碗型塑膠手輪 Soild Plastic Handwheels

3501

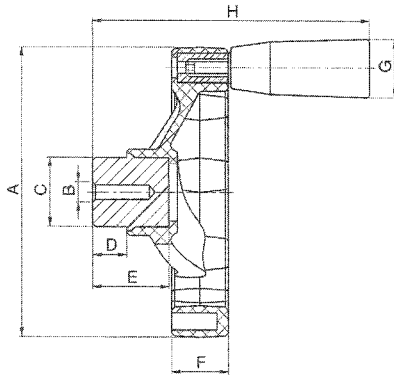
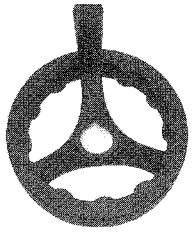

名稱 Name	材質 Material	表面處理 Surfaced process
手輪 Handwheel	尼龍加玻璃纖維 (KT)	黑色 Black
軸 Spindle	鋼鐵 Steel (ST)	
把手 Handle	尼龍加玻璃纖維 (KT)	黑色 Black

(mm)

Order No. 型號 (KT)	A	B	C	D	E	F	G	H
3501 - 100 - B4	100	B4	24	12	24	20	21	96
- 125 - B6	125	B6	24	12	28	24	21	101
- 160 - B6	160	B6	32	15	31	28	23	131
- 200 - B6	200	B6	40	15	40	32	26	161

碗型塑膠手輪 Soild Plastic Handwheels

3502

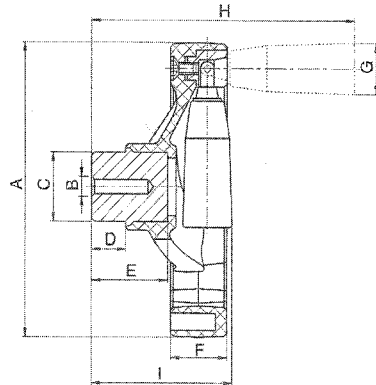
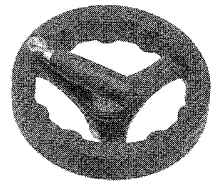

名稱 Name	材質 Material	表面處理 Surfaced process
手輪 Handwheel	尼龍加玻璃纖維 (KT)	黑色 Black
軸 Spindle	鋼鐵 Steel (ST)	
把手 Handle	尼龍加玻璃纖維 (KT)	黑色 Black
折疊結構 Retractable mechanism	鋼鐵 Steel (ST)	

(mm)

Order No. 型號 (KT)	A	B	C	D	E	F	G	H	I
3502 - 100 - B4	100	B4	24	12	24	20	21	100	90
- 125 - B6	125	B6	24	12	28	24	21	105	94
- 160 - B6	160	B6	32	15	31	28	23	135	95
- 200 - B6	200	B6	40	15	40	32	26	165	110

[61]

碗型塑膠手輪 Soild Plastic Handwheels

3510

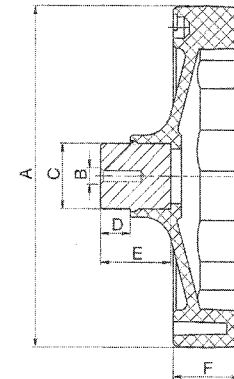
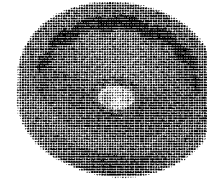

名稱 Name	材質 Material
手輪 Handwheel	尼龍加玻璃纖維 (KT)
軸 Spindle	鋼鐵 Steel (ST)

(mm)

Order No. 型號 (KT)	A	B	C	D	E	F
3510 - 100 - B4	100	B4	24	12	24	20
- 125 - B6	125	B6	24	12	28	24
- 160 - B6	160	B6	32	15	31	28
- 200 - B6	200	B6	40	15	40	32

碗型塑膠手輪 Soild Plastic Handwheels

3511

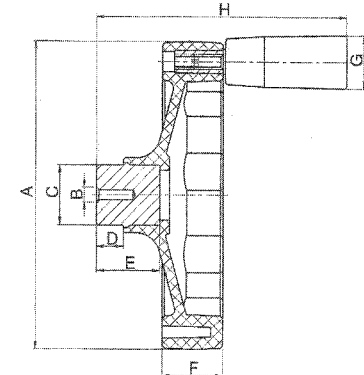
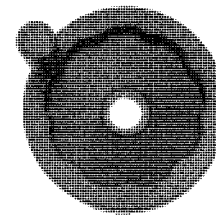

名稱 Name	材質 Material	表面處理 Surfaced process
手輪 Handwheel	尼龍加玻璃纖維 (KT)	黑色 Black
軸 Spindle	鋼鐵 Steel (ST)	
把手 Handle	尼龍加玻璃纖維 (KT)	黑色 Black

(mm)

Order No. 尼龍加玻璃纖維 (KT)	A	B	C	D	E	F	G	H
3511 - 100 - B4	100	B4	24	12	24	20	21	96
- 125 - B6	125	B6	24	12	28	24	21	101
- 160 - B6	160	B6	32	15	31	28	23	131
- 200 - B6	200	B6	40	15	40	32	26	164

[62]

碗型塑膠手輪 Soild Plastic Handwheels

3512

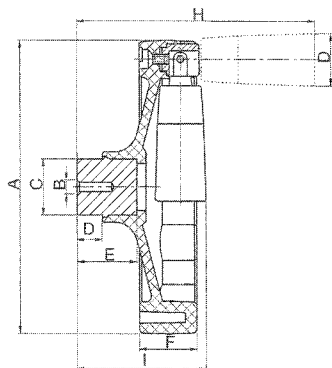
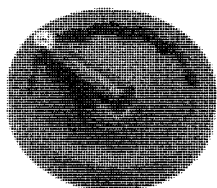

名稱 Name	材質 Material	表面處理 Surfaced process
手輪 Handwheel	尼龍加玻璃纖維 (KT)	黑色 Black
軸 Spindle	鋼鐵 Steel (ST)	
把手 Handle	尼龍加玻璃纖維 (KT)	
折疊結構 Retractable mechanism	鋼鐵 Steel (ST)	

(mm)

Order No. 尼龍加玻璃纖維 (KT)	A	B	C	D	E	F	G	H	I
3512 - 100 - B4	100	B4	24	12	24	20	21	28	50
- 125 - B4	125	B4	24	12	24	21	21	28	54
- 150 - B6	150	B6	32	15	31	23	23	35	65
- 200 - B6	200	B6	40	15	40	23	26	40	70

碗型塑膠手輪 Soild Plastic Handwheels

3520

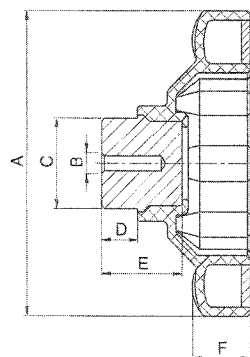
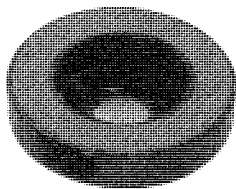

名稱 Name	材質 Material
手輪 Handwheel	尼龍加玻璃纖維 (KT)
軸 Spindle	鋼鐵 Steel (ST)

(mm)

Order No. 尼龍加玻璃纖維 (KT)	A	B	C	D	E	F
3520 - 100 - B4	100	B4	30	12	28	21
- 125 - B4	125	B4	30	12	28	21
- 150 - B6	150	B6	40	15	35	26
- 175 - B6	175	B6	40	15	35	27
- 200 - B6	200	B6	40	15	40	28

[63]

碗型塑膠手輪 Soild Plastic Handwheels

3521

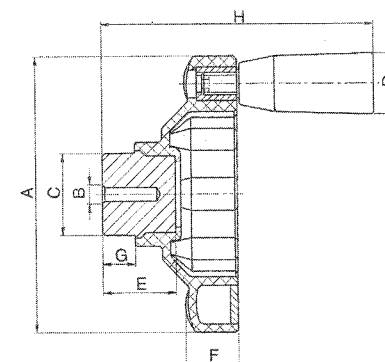
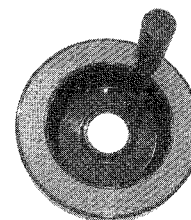

名稱 Name	材質 Material	表面處理 Surfaced process
手輪 Handwheel	尼龍加玻璃纖維 (KT)	黑色 Black
軸 Spindle	鋼鐵 Steel (ST)	
把手 Handle	尼龍加玻璃纖維 (KT)	

(mm)

Order No. 尼龍加玻璃纖維 (KT)	A	B	C	D	E	F	G	H
3521 - 100 - B4	100	B4	30	12	28	21	21	100
- 125 - B4	125	B4	30	12	28	21	21	104
- 150 - B6	150	B6	40	15	35	26	23	130
- 175 - B6	175	B6	40	15	35	27	26	153
- 200 - B6	200	B6	40	15	40	28	26	158

碗型塑膠手輪 Soild Plastic Handwheels

3522

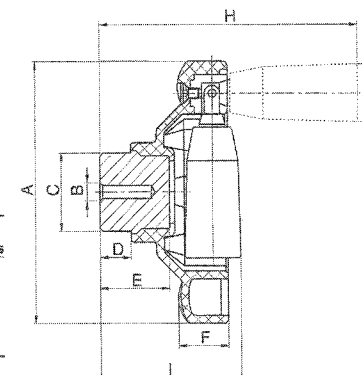
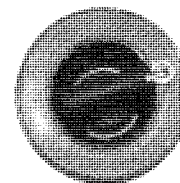

名稱 Name	材質 Material	表面處理 Surfaced process
手輪 Handwheel	尼龍加玻璃纖維 (KT)	黑色 Black
軸 Spindle	鋼鐵 Steel (ST)	
把手 Handle	尼龍加玻璃纖維 (KT)	
折疊結構 Retractable mechanism	鋼鐵 Steel (ST)	

(mm)

Order No. 尼龍加玻璃纖維 (KT)	A	B	C	D	E	F	G	H	I
3522 - 100 - B4	100	B4	30	12	28	21	21	102	54
- 125 - B4	125	B4	30	12	28	21	21	106	57
- 150 - B6	150	B6	40	15	35	26	23	132	65
- 175 - B6	175	B6	40	15	35	27	26	155	69
- 200 - B6	200	B6	40	15	40	28	26	160	74

[64]

可調式把手 Adjustable Hand Levers

4010

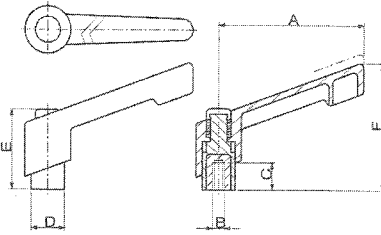

名稱 Name	材質 Material	表面處理 Surface process
把手 Handle	尼龍加玻璃纖維 (KT)	全橘色 Orange (OR)
軸 Spindle	鋼鐵 Steel (ST)	全黑色 Black (BK)
	鍍鋅 Zincing (ZI)	橘色鉅黑色柄 Orange knob and black handle (OB)
		黑色鉅橘色柄 Black knob and orange handle (BO)

(mm)

Order No. 尼龍加玻璃纖維 (KT)	A	B	C	D	E	F
4010 - A - B - 顏色 (Color)	42	M5	8	12	24.5	33.5
	42	M6	8	12	24.5	33.5
表面顏色 Surfaced color	65	M6	10	13.5	31	45.5
內螺紋 Internal thread	65	M8	10	13.5	31	45.5
手柄長度 Handle length	80	M10	14	16	36	54
	80	M12	14	16	36	54

可調式把手 Adjustable Hand Levers

4020

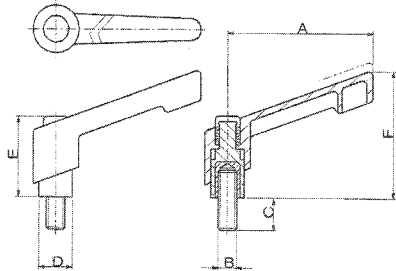
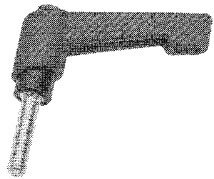

名稱 Name	材質 Material	表面處理 Surface process
把手 Handle	尼龍加玻璃纖維 (KT)	全橘色 Orange (OR)
軸 Spindle	鋼鐵 Steel (ST)	全黑色 Black (BK)
	鍍鋅 Zincing (ZI)	橘色鉅黑色柄 Orange knob and black handle (OB)
		黑色鉅橘色柄 Black knob and orange handle (BO)

(mm)

Order No. 尼龍加玻璃纖維 (KT)	A	B	C	D	E	F						
4020 - A - B - C - 顏色 (Color)	42	M5	10	15	20	25	30	—	—	12	24.5	33.5
	42	M6	10	15	20	25	30	—	—	12	24.5	33.5
表面顏色 Surfaced color	65	M6	10	15	20	25	30	—	—	13.5	31	45.5
螺紋長度 Thread length	65	M8	10	15	20	25	30	—	—	13.5	31	45.5
外螺紋 External thread	80	M10	—	—	20	25	30	40	50	16	36	54
手柄長度 Handle length	80	M12	—	—	20	25	30	40	50	16	36	54

可調式把手 Adjustable Hand Levers

4030

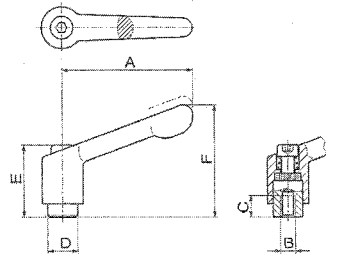
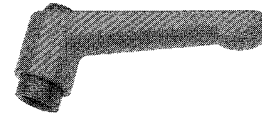

名稱 Name	材質 Material	表面處理 Surface process
把手 Handle	鋅壓鑄 Zinc die casting (ZD)	黑色烤漆 Paint black (BK)
軸 Spindle	鋼鐵 Steel (ST)	橘色烤漆 Paint orange (OR)
	染黑 Dyed black (B)	銀色烤漆 Paint silver (SR)

(mm)

Order No. 鋅壓鑄 (ZD)	A	B	C	D	E	F
4030 - A - B - 顏色 (Color)	45	M4	8	10	24.5	35
	45	M5	8	10	24.5	35
	45	M6	8	10	24.5	35
表面顏色 Surfaced color	63	M6	10	13.5	31	45
內螺紋 Internal thread	63	M8	10	13.5	31	45
手柄長度 Handle length	78	M8	14	16	36	55
	78	M10	14	16	36	55
	92	M10	17	19	43	65
	92	M12	17	19	43	65
	108	M12	22	23	50.5	76
	108	M14	22	23	50.5	76
	108	M16	22	23	50.5	76

可調式把手 Adjustable Hand Levers

4031

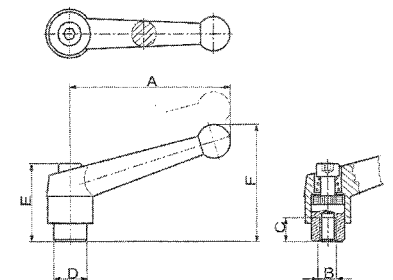
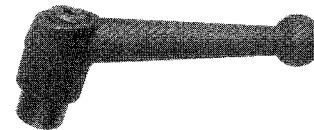

名稱 Name	材質 Material	表面處理 Surface process
把手 Handle	精密 (脫臘) 不銹鋼	黑色烤漆 Paint black (BK)
	Precision ST. steel	橘色烤漆 Paint orange (OR)
軸 Spindle	鋼鐵 Steel (ST)	銀色烤漆 Paint silver (SR)
	染黑 Dyed black (B)	

(mm)

Order No. 精密 (脫臘) 不銹鋼	A	B	C	D	E	F
4031 - A - B - 顏色 (Color)	63	M6	10	13.5	31	45
	63	M8	10	13.5	31	45
表面顏色 Surfaced color	78	M8	14	16	36	55
內螺紋 Internal thread	78	M10	14	16	36	55
手柄長度 Handle length	92	M10	17	19	43	65
	92	M12	17	19	43	65

可調式把手 Adjustable Hand Levers

4032

NEW

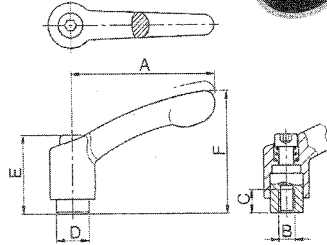
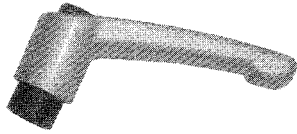

名稱 Name	材質 Material	表面處理 Surface process
把手 Handle	鋅壓鑄 Zinc die casting (ZD)	黑色烤漆 Paint black (BK)
軸 Spindle	鋼鐵 Steel (ST)	橘色烤漆 Paint orange (OR)
	鍍鋅 Zincing (ZI)	銀色烤漆 Paint silver (SR)

(mm)

Order No. 鋅壓鑄 (ZD)	A	B	C	D	E	F
4032 - A - B - 顏色 (Color)	45	M4	8	10	24.5	35
	45	M5	8	10	24.5	35
	45	M6	8	10	24.5	35
	63	M6	10	13.5	31	45
	63	M8	10	13.5	31	45
	78	M8	14	16	36	55
	78	M10	14	16	36	55
	92	M10	17	19	43	65
	92	M12	17	19	43	65
	108	M12	22	23	50.5	76
	108	M14	22	23	50.5	76
108	M16	22	23	50.5	76	

可調式把手 Adjustable Hand Levers

4040

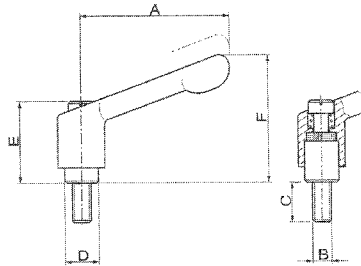
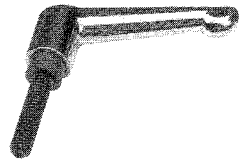

名稱 Name	材質 Material	表面處理 Surface process
把手 Handle	鋅壓鑄 Zinc die casting (ZD)	黑色烤漆 Paint black (BK)
軸 Spindle	鋼鐵 Steel (ST)	橘色烤漆 Paint orange (OR)
	染黑 Dyed black (B)	銀色烤漆 Paint silver (SR)

(mm)

Order No. 鋅壓鑄 (ZD)	A	B	C	D	E	F
4040 - A - B - C - 顏色 (Color)	45	M5	10 15 20 25 30	-	10	24.5 35
	45	M6	10 - 20 - 30 40 50	-	10	24.5 35
	45	M8	10 - 20 - 30 40 50	-	10	24.5 35
	63	M8	10 - 20 - 30 40 50	-	13.5	31 45
	63	M10	10 - 20 - 30 40 50	-	13.5	31 45
	78	M8	10 - 20 - 30 40 50	-	16	36 55
	78	M10	10 - 20 - 30 40 50	-	16	36 55
	78	M12	10 - 20 - 30 40 50	-	16	36 55
	92	M10	- - 20 - 30 40 50 60	-	19	43 65
	92	M12	- - 20 - 30 40 50 60	-	19	43 65
	108	M12	- - - 30 40 50 60 70	-	23	50.5 76
108	M16	- - - - 40 50 60 70 80	-	23	50.5 76	

[67]

可調式把手 Adjustable Hand Levers

4041

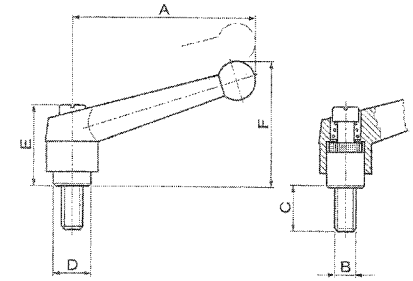
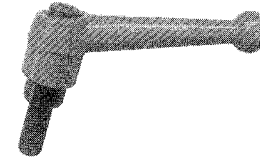

名稱 Name	材質 Material	表面處理 Surface process
把手 Handle	精密 (脫臘) 不銹鋼 Precision ST. steel	黑色烤漆 Paint black (BK)
軸 Spindle	鋼鐵 Steel (ST)	橘色烤漆 Paint orange (OR)
	染黑 Dyed black (B)	銀色烤漆 Paint silver (SR)

(mm)

Order No. 精密 (脫臘) 不銹鋼	A	B	C	D	E	F
4041 - A - B - C - 顏色 (Color)	63	M8	10 20 30 - - -	13.5	31	45
	63	M10	10 20 30 40 50 - - -	13.5	31	45
	78	M8	10 20 30 40 50 - - -	16	36	55
	78	M10	10 20 30 40 50 - - -	16	36	55
	78	M12	10 20 30 40 50 - - -	16	36	55
	92	M10	- - 20 30 40 50 60	19	43	65
	92	M12	- - 20 30 40 50 60	19	43	65

可調式把手 Adjustable Hand Levers

4042

NEW

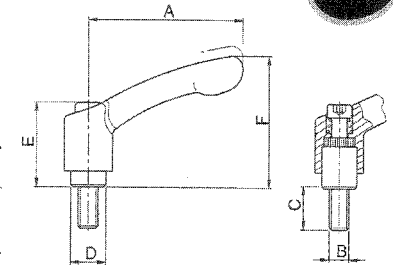

名稱 Name	材質 Material	表面處理 Surface process
把手 Handle	鋅壓鑄 Zinc die casting (ZD)	黑色烤漆 Paint black (BK)
軸 Spindle	鋼鐵 Steel (ST)	橘色烤漆 Paint orange (OR)
	鍍鋅 Zincing (ZI)	銀色烤漆 Paint silver (SR)

(mm)

Order No. 鋅壓鑄 (ZD)	A	B	C	D	E	F
4042 - A - B - C - 顏色 (Color)	45	M5	10 15 20 30 - - -	10	24.5	35
	45	M6	10 - 20 30 40 50 - - -	10	24.5	35
	45	M8	10 - 20 30 40 50 - - -	10	24.5	35
	63	M8	10 - 20 30 40 50 - - -	13.5	31	45
	63	M10	10 - 20 30 40 50 - - -	13.5	31	45
	78	M8	10 - 20 30 40 50 - - -	16	36	55
	78	M10	10 - 20 30 40 50 - - -	16	36	55
	78	M12	10 - 20 30 40 50 - - -	16	36	55
	92	M10	- - 20 30 40 50 60	19	43	65
	92	M12	- - 20 30 40 50 60	19	43	65
	108	M12	- - - 30 40 50 60 70	23	50.5	76
108	M16	- - - - 30 40 50 60 70 80	23	50.5	76	

[68]

不銹鋼可調式把手 ST. Steel Adjustable Hand Levers

4050

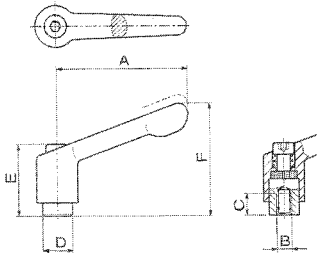
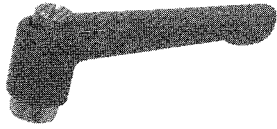

名稱	材質	表面處理
Name	Material	Surfaced process
把手 Handle	鋅壓鑄 Zinc die casting (ZD)	黑色烤漆 Paint black (BK)
軸 Spindle	不銹鋼 Stainless steel (SST)	橘色烤漆 Paint orange (OR)
		銀色烤漆 Paint silver (SR)

(mm)

Order No. 鋅壓鑄 (ZD)	A	B	C	D	E	F
4050 - A - B - 顏色 (Color)	45	M4	8	10	24.5	35
	45	M5	8	10	24.5	35
	45	M6	8	10	24.5	35
表面顏色 Surfaced color	63	M6	10	13.5	31	45
內螺紋 Internal thread	63	M8	10	13.5	31	45
手柄長度 Handle length	78	M8	14	16	36	55
	78	M10	14	16	36	55
	92	M10	17	19	43	65
	92	M12	17	19	43	65
	108	M12	22	23	50.5	76
	108	M14	22	23	50.5	76
	108	M16	22	23	50.5	76

不銹鋼可調式把手 ST. Steel Adjustable Hand Levers

4052

NEW

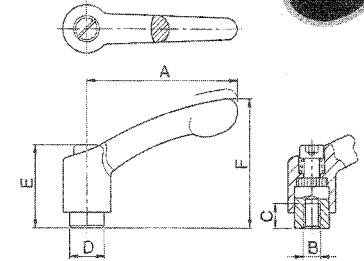
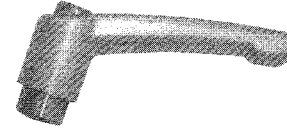

名稱	材質	表面處理
Name	Material	Surfaced process
把手 Handle	鋅壓鑄 Zinc die casting (ZD)	黑色烤漆 Paint black (BK)
軸 Spindle	不銹鋼 Stainless steel (SST)	橘色烤漆 Paint orange (OR)
		銀色烤漆 Paint silver (SR)

(mm)

Order No. 鋅壓鑄 (ZD)	A	B	C	D	E	F
4052 - A - B - 顏色 (Color)	45	M4	8	10	24.5	35
	45	M5	8	10	24.5	35
	45	M6	8	10	24.5	35
表面顏色 Surfaced color	63	M6	10	13.5	31	45
內螺紋 Internal thread	63	M8	10	13.5	31	45
手柄長度 Handle length	78	M8	14	16	36	55
	78	M10	14	16	36	55
	92	M10	17	19	43	65
	92	M12	17	19	43	65
	108	M12	22	23	50.5	76
	108	M14	22	23	50.5	76
	108	M16	22	23	50.5	76

不銹鋼可調式把手 ST. Steel Adjustable Hand Levers

4051

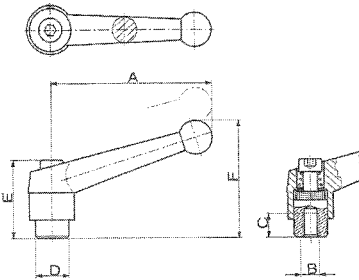
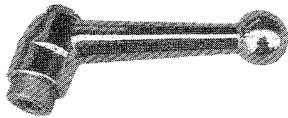

名稱	材質	表面處理
Name	Material	Surfaced process
把手 Handle	精密 (脫臘) 不銹鋼 Precision ST. steel	黑色烤漆 Paint black (BK)
		橘色烤漆 Paint orange (OR)
軸 Spindle	不銹鋼 Stainless steel (SST)	銀色烤漆 Paint silver (SR)

(mm)

Order No. 精密 (脫臘) 不銹鋼	A	B	C	D	E	F
4051 - A - B - 顏色 (Color)	63	M6	10	13.5	31	45
	63	M8	10	13.5	31	45
表面顏色 Surfaced color	78	M8	14	16	36	55
內螺紋 Internal thread	78	M10	14	16	36	55
手柄長度 Handle length	92	M10	17	19	43	65
	92	M12	17	19	43	65

[69]

不銹鋼可調式把手 ST. Steel Adjustable Hand Levers

4060

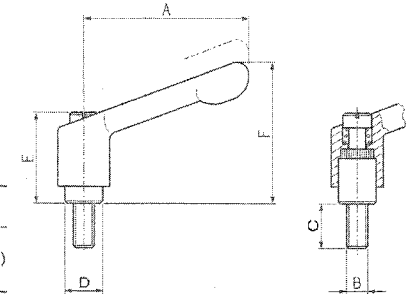
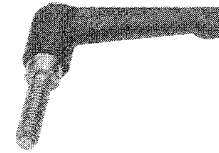

名稱	材質	表面處理
Name	Material	Surfaced process
把手 Handle	鋅壓鑄 Zinc die casting (ZD)	黑色烤漆 Paint black (BK)
軸 Spindle	不銹鋼 Stainless steel (SST)	橘色烤漆 Paint orange (OR)
		銀色烤漆 Paint silver (SR)

(mm)

Order No. 鋅壓鑄 (ZD)	A	B	C	D	F	E
4060 - A - B - C - 顏色 (Color)	45	M5	10	15	20	25
	45	M6	10	15	20	25
表面顏色 Surfaced color	63	M6	10	15	20	25
螺紋長度 Thread length	63	M8	10	15	20	25
外螺紋 External thread	78	M8	10	15	20	25
手柄長度 Handle length	78	M10	10	15	20	25
	92	M10	10	15	20	25
	92	M12	10	15	20	25
	108	M12	10	15	20	25
	108	M16	10	15	20	25

[70]

不銹鋼可調式把手 4061

ST. Steel Adjustable Hand Levers

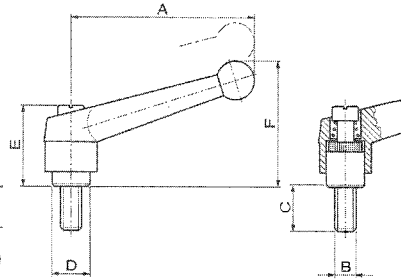
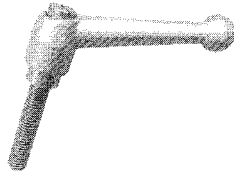

名稱	材質	表面處理
Name	Material	Surfaced process
把手 Handle	精密(脫臘)不銹鋼 Precision ST. steel	黑色烤漆 Paint black (BK) 橘色烤漆 Paint orange (OR) 銀色烤漆 Paint silver (SR)
軸 Spindle	不銹鋼 Stainless steel (SST)	

(mm)

Order No. 精密(脫臘)不銹鋼	A	B	C				D	E	F		
4061 - A - B - C - 顏色 (Color)	63	M8	10	20	30	40	50	-	13.5	31	45
表面顏色 Surfaced color	78	M8	10	20	30	40	50	-	16	36	55
螺紋長度 Thread length	78	M10	10	20	30	40	50	-	16	36	55
外螺紋 External thread	92	M10	-	20	30	40	50	60	19	43	65
手柄長度 Handle length	92	M12	-	20	30	40	50	60	19	43	65

不銹鋼可調式把手 4062

ST. Steel Adjustable Hand Levers

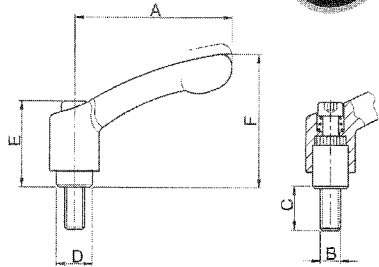
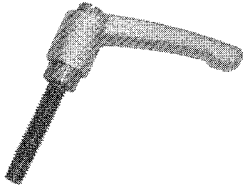

名稱	材質	表面處理
Name	Material	Surfaced process
把手 Handle	鋅壓鑄 Zinc die casting (ZD)	黑色烤漆 Paint black (BK) 橘色烤漆 Paint orange (OR) 銀色烤漆 Paint silver (SR)
軸 Spindle	不銹鋼 Stainless steel (SST)	

(mm)

Order No. 鋅壓鑄 (ZD)	A	B	C				D	F	E					
4062 - A - B - C - 顏色 (Color)	45	M5	10	15	20	25	30	-	10	24.5	35			
表面顏色 Surfaced color	45	M6	10	-	20	-	30	40	50	-	10	24.5	35	
螺紋長度 Thread length	63	M6	10	-	20	-	30	40	50	-	13.5	31	45	
外螺紋 External thread	63	M8	10	-	20	-	30	40	50	-	13.5	31	45	
手柄長度 Handle length	78	M8	10	-	20	-	30	40	50	-	16	36	55	
	78	M10	10	-	20	-	30	40	50	-	16	36	55	
	92	M10	-	20	-	-	30	40	50	60	-	19	43	65
	92	M12	-	20	-	-	30	40	50	60	-	19	43	65
	108	M12	-	-	-	-	30	40	50	60	70	23	50.5	76
	108	M16	-	-	-	-	40	50	60	70	80	23	50.5	76

[71]

萬向把手 4070

Adjustable Tension Levers

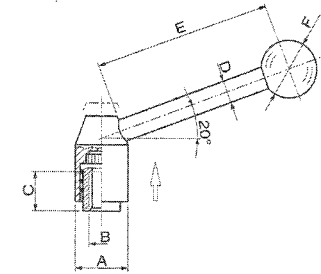

名稱	材質	表面處理
Name	Material	Surfaced process
把手 Handle	鋼鐵 Steel (ST)	電鍍黑色 Matt black (B)
軸 Spindle	鋼鐵 Steel (ST)	鍍鋅 Zincing (ZI)
旋鈕 Knob	電木 Bakelite (KU)	

(mm)

Order No. 鋼鐵 (ST)	A	B	C	D	E	F
4070 - 21 - M6	21	M6	10	8	70	20
- 21 - M8	21	M8	10	8	70	20
- 24 - M8	24	M8	14	10	96	25
- 24 - M10	24	M10	14	10	96	25
- 28 - M10	28	M10	17	12	110	30
- 28 - M12	28	M12	17	12	110	30
- 33 - M12	33	M12	23	12	124	32
- 33 - M16	33	M16	23	12	124	32
- 40 - M16	40	M16	36	14	138	35
- 40 - M20	40	M20	36	14	138	35

萬向把手 4080

Adjustable Tension Levers

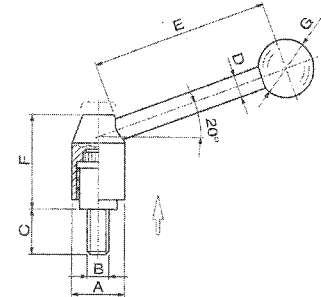
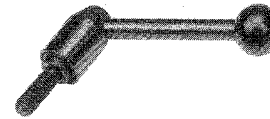

名稱	材質	表面處理
Name	Material	Surfaced process
把手 Handle	鋼鐵 Steel (ST)	電鍍黑色 Matt black (B)
軸 Spindle	鋼鐵 Steel (ST)	鍍鋅 Zincing (ZI)
旋鈕 Knob	電木 Bakelite (KU)	

(mm)

Order No. 鋼鐵 (ST)	A	B	C				D	E	F	G			
4080 - A - B - C	21	M8	10	20	30	40	50	-	8	70	33.5	20	
螺紋長度 Thread length	21	M10	10	20	30	40	50	-	8	70	33.5	20	
外螺紋 External thread	24	M10	10	20	30	40	50	-	10	96	40	25	
外徑 Outside diameter	24	M12	10	20	30	40	50	-	10	96	40	25	
	28	M10	10	20	30	40	50	-	12	110	48.5	30	
	28	M12	10	20	30	40	50	-	12	110	48.5	30	
	33	M12	-	20	30	40	50	60	-	12	124	55	32
	33	M16	-	20	30	40	50	60	-	12	124	55	32
	40	M16	-	30	40	50	60	70	-	14	138	68	35
	40	M20	-	30	40	50	60	70	80	14	138	68	35

[72]

不銹鋼萬向把手 ST. Steel Adjustable Hand Levers

4090

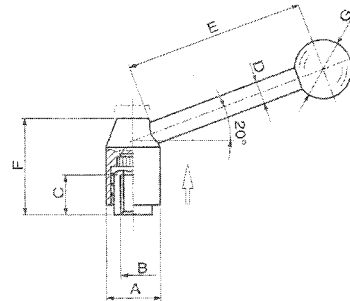

名稱 Name	材質 Material	表面處理 Surface process
把手 Handle	不銹鋼 Stainless steel (SST)	黑色 Black
旋鈕 Knob	電木 Bakelite (KU)	黑色 Black
軸 Spindle	不銹鋼 Stainless steel (SST)	

(mm)

Order No. 不銹鋼 (SST)	A	B	C	D	E	F	G
4090 - 21 - M 6	21	M6	10	8	70	33.5	20
- 21 - M 8	21	M8	10	8	70	33.5	20
- 24 - M 8	24	M8	14	10	96	40	25
- 24 - M10	24	M10	14	10	96	40	25
- 28 - M10	28	M10	17	12	110	48.5	30
- 28 - M12	28	M12	17	12	110	48.5	30

不銹鋼萬向把手 ST. Steel Adjustable Hand Levers

4100

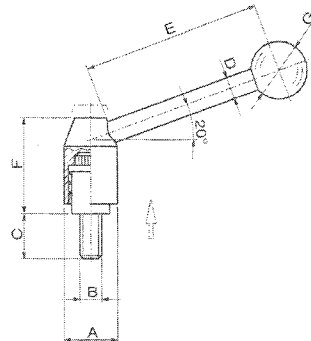
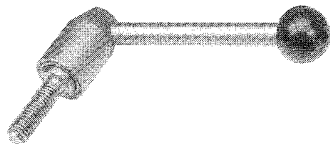

名稱 Name	材質 Material	表面處理 Surface process
把手 Handle	不銹鋼 Stainless steel (SST)	黑色 Black
旋鈕 Knob	電木 Bakelite (KU)	黑色 Black
軸 Spindle	不銹鋼 Stainless steel (SST)	

(mm)

Order No. 不銹鋼 (SST)	A	B	C				D	E	F	G			
4100 - A - B - C	21	M8	20	25	30	40	50	8	70	33.5	20		
螺紋長度 Thread length	24	M10	-	-	30	40	50	60	80	10	96	40	25
外螺紋 External thread	28	M12	-	-	30	40	50	60	80	12	110	48.5	30
外徑 Outside diameter													

[73]

平頭萬向把手 Flat Adjustable Tension Levers

4110

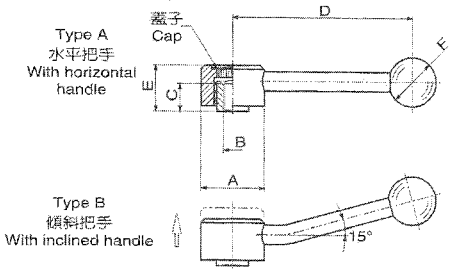
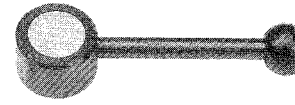

名稱 Name	材質 Material	表面處理 Surface process
把手 Handle	鋼鐵 Steel (ST)	電鍍黑色 Matt black (B)
旋鈕 Knob	電木 Bakelite (KU)	黑色 Black
蓋子 Cap	鋁合金 Aluminum (AL)	鍍霧銀 Matt silver (EL)
軸 Spindle	鋼 Steel	鍍鋅 Zincing

(mm)

Order No. Type A	Order No. Type B	A	B	C	D	E	F
4110 - 32 - M 6	4111 - 32 - M 6	32	M6	11	100	20.5	20
- 32 - M 8	- 32 - M 8	32	M8	11	100	20.5	20
- 36 - M 8	- 36 - M 8	36	M8	14	120	24.5	25
- 36 - M10	- 36 - M10	36	M10	14	120	24.5	25
- 40 - M10	- 40 - M10	40	M10	17	130	26.5	30
- 40 - M12	- 40 - M12	40	M12	17	130	26.5	30
- 45 - M12	- 45 - M12	45	M12	23	145	31.5	32
- 45 - M16	- 45 - M16	45	M16	23	145	31.5	32

平頭萬向把手 Flat Adjustable Tension Levers

4120

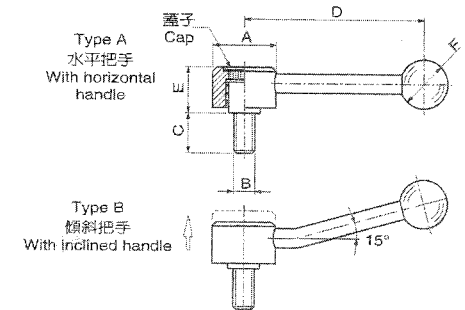
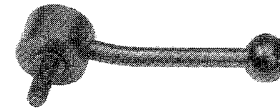

名稱 Name	材質 Material	表面處理 Surface process
把手 Handle	鋼鐵 Steel (ST)	電鍍黑色 Matt black (B)
旋鈕 Knob	電木 Bakelite (KU)	黑色 Black
蓋子 Cap	鋁合金 Aluminum (AL)	鍍霧銀 Matt silver (EL)
軸 Spindle	鋼 Steel	鍍鋅 Zincing

(mm)

Order No. Type A	Order No. Type B	A	B	C				D	E	F			
4120 - A - B - C	4121 - A - B - C	32	M8	15	20	25	30	40	100	20.5	20		
螺紋長度 Thread length	32	M8	15	20	25	30	40	50	100	20.5	20		
外螺紋 External thread	36	M10	15	20	25	30	40	50	120	24.5	25		
外徑 Outside diameter	36	M12	15	20	25	30	40	50	120	24.5	25		
	40	M10	-	20	25	30	40	50	130	26.5	30		
	40	M12	-	20	25	30	40	50	130	26.5	30		
	45	M12	-	25	30	40	50	60	145	31.5	32		
	45	M16	-	25	30	40	50	60	145	31.5	32		
	50	M16	-	-	-	40	50	60	70	80	150	33.5	35
	50	M16	-	-	-	40	50	60	70	80	150	33.5	35

[74]

錐柱把手 Clamping Levers

5010



Type A
水平把手
Horizontal handle

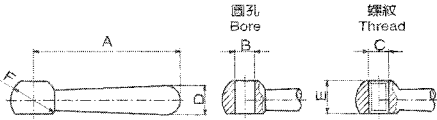

Type B
傾斜把手
Inclined handle

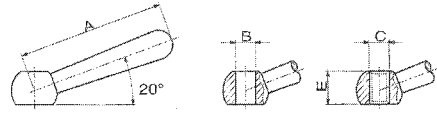

名稱 Name	材質 Material
把手 Handle	鋼鐵 Steel (ST)

(mm)

Order No. (Type A)	Order No. (Type B)	A	B	C	D	E	F
5010-40-B3	5010-40-M3	40	5	M3	8	9	12
50-43	50-43	50	5	M3	8	9	14
50-43	50-43	50	5	M3	10	11	16
50-50	50-50	50	10	M10	13	14	20
50-100	50-100	100	12	M12	18	18	25
50-125	50-125	125	15	M15	20	22	30
50-150	50-150	150	20	M20	25	28	40
500-200	500-200	200	25	M24	32	36	50

煙斗把手 Tension Levers

5020

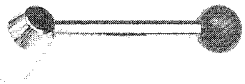

Type A
水平把手
Horizontal handle

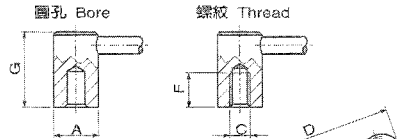

Type B
傾斜把手
Inclined handle

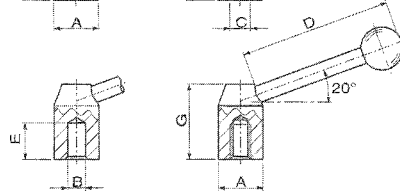

名稱 Name	材質 Material	表面處理 Surface process
把手 Handle	鋼鐵 Steel (ST)	
旋鈕 Knob	電木 Bakelite (KU)	黑色 Black

(mm)

Order No. (Type A)	Order No. (Type B)	A	B	C	D	E	F	G
5020-20-B3	5020-20-M3	20	5	M3	70	17	15	33
25-B10	25-M10	25	10	M10	62	15	15	37
25-B12	25-M12	25	12	M12	65	21	18	42
25-B15	25-M15	25	15	M15	77	23	18	47
32-B16	32-M16	32	16	M16	124	25	23	52
32-B18	32-M18	32	18	M18	135	27	24	58
40-B20	40-M20	40	20	M20	152	29	27	64
40-B22	40-M22	40	22	M22	170	31	30	71
50-B25	50-M24	50	25	M24	195	32	32	76

控制把手 Control Levers

5030

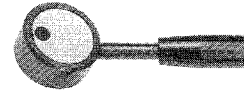

Type A
蓋子無標點
Cap without mark

Type B
蓋子有標點
Cap mark

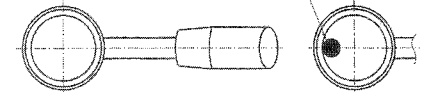

名稱 Name	材質 Material	表面處理 Surface process
本體 Base metal	鋼鐵 Steel (ST)	電鍍黑色 Matt black (B)
把手 Handle	鋼鐵 Steel (ST)	黑色 Black
蓋子 Cap	鋁合金 Aluminum (AL)	鍍霧銀 Matt silver (EL)
軸 Spindle	鋼 Steel	鍍鋅 Zincing

(mm)

Order No. (Type A)	Order No. (Type B)	A	B	C	D	E	F
5030-32-B10	5031-32-B10	32	B10	18	8	24	21
40-B10	40-B10	40	B10	22	10	26	25
50-B14	50-B14	50	B14	23	12	33	28
50-B15	50-B15	50	B15	25	12	35	29

控制把手 Control Levers

5035

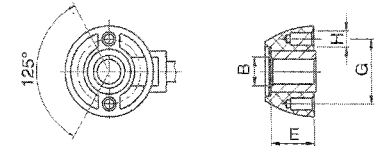
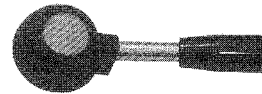

名稱 Name	材質 Material	表面處理 Surface process
本體 Base metal	鋼鐵 Steel (ST)	黑色 Black
把手 Handle	鋼織 Steel (ST)	
	尼龍加玻璃纖維 (KT)	

(mm)

Order No. (Type A)	A	B	C	D	E	F	G	H	I
5035-40-B3	40	B3	25	22	108	32	8	21 x 50	
45-B12	45	B12	25	22	135	32	8	21 x 50	
45-B15	45	B15	25	22	108	32	8	21 x 50	
50-B10	50	B10	100	30	127	38	8	23 x 55	
50-B14	50	B14	100	30	27	127	38	8	23 x 55
50-B15	50	B15	105	30	27	127	38	8	23 x 55

控制把手 Control Levers

5051

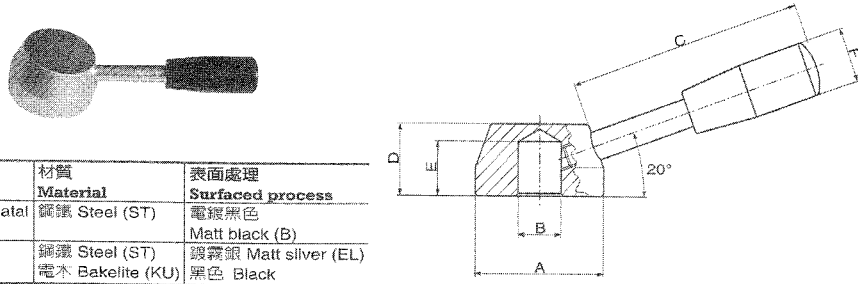

名稱 Name	材質 Material	表面處理 Surfaced process
本體 Base metal	鋼鐵 Steel (ST)	電鍍黑色 Matt black (B)
把手 Handle	鋼鐵 Steel (ST) 電木 Bakelite (KU)	鍍霧銀 Matt silver (EL) 黑色 Black

(mm)

Order No. 鋼鐵 (ST)	A	B	C	D	E	F
5051 - 40 - B10	40	B10	98	22	14	22
- 45 - B12	45	B12	123	25	16	22
- 50 - B12	50	B12	122	26	18	23
- 54 - B14	54	B14	157	30	20	23
- 60 - B16	60	B16	156	32	21	26
- 70 - B18	70	B18	196	32	21	26
- 80 - B22	80	B22	195	36	24	28

砲塔式把手 Turret Levers

5060

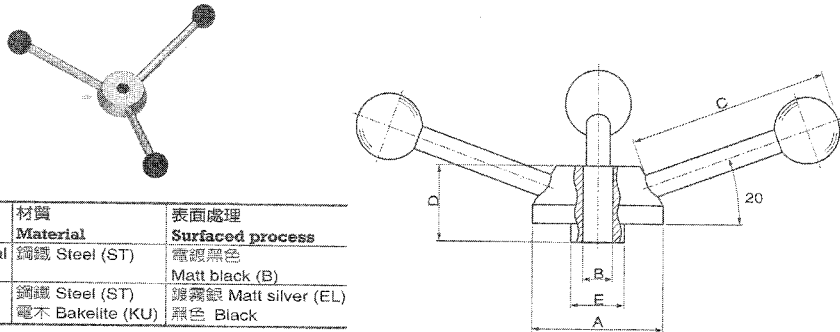

名稱 Name	材質 Material	表面處理 Surfaced process
本體 Base metal	鋼鐵 Steel (ST)	電鍍黑色 Matt black (B)
把手 Handle	鋼鐵 Steel (ST) 電木 Bakelite (KU)	鍍霧銀 Matt silver (EL) 黑色 Black

(mm)

Order No. 鋼鐵 (ST)	A	B	C	D	E
5060 - 50 - B12	50	B12	82	26	28
- 55 - B14	55	B14	96	28	30
- 60 - B15	60	B15	96	30	32
- 65 - B16	65	B16	124	32	35
- 72 - B18	72	B18	124	36	40
- 80 - B20	80	B20	138	40	44
- 100 - B24	100	B24	170	52	54

[77]

電木雙桿砲塔式把手 Bakelite Two Arms Turret Levers

5065

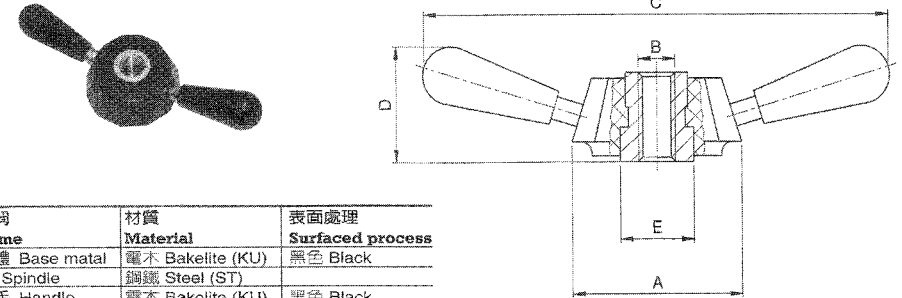

名稱 Name	材質 Material	表面處理 Surfaced process
本體 Base metal	電木 Bakelite (KU)	黑色 Black
軸 Spindle	鋼鐵 Steel (ST)	
把手 Handle	電木 Bakelite (KU)	黑色 Black

(mm)

Order No. 電木 (KU)	螺紋 Thread	鋼孔 Bore	A	B	C	D	E	
5065 - 230 - M22	5065 - 230 - B10		230	M22	B10	88	65	38
- 275 - M22	- 275 - B10		275	M22	B10	88	70	38
- 340 - M22	- 340 - B10		340	M22	B10	88	84	38
- 400 - M22	- 400 - B10		400	M22	B10	88	95	38

把手調整座 Split Hubs

5070

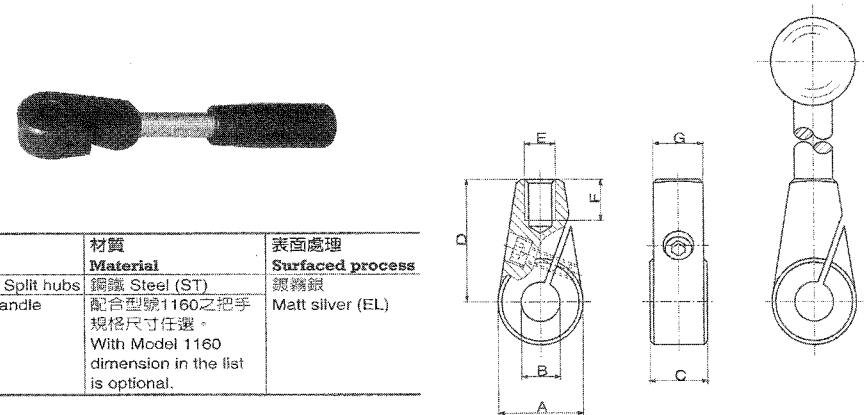

名稱 Name	材質 Material	表面處理 Surfaced process
調整座 Split hubs	鋼鐵 Steel (ST)	鍍霧銀 Matt silver (EL)
把手 Handle	配合型號1160之把手 規格尺寸任選。 With Model 1160 dimension in the list is optional.	

(mm)

Order No. 鋼鐵 (ST)	A	B	C	D	E	F	G
5070 - 24 - 36	24	B12	15.5	36	M8	11	13
- 28 - 41	28	B14	17.5	41	M10	14	15
- 32 - 45	32	B16	19.5	45	M12	16	17

[78]

星型旋鈕 Hand Knobs

6010

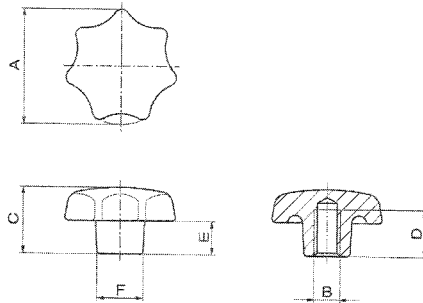

名稱 Name	材質 Material	表面處理 Surface process
本體 Base metal	鑄鐵 Cast iron (CI)	黃色烤漆 Paint yellow (YE) 紅色烤漆 Paint red (RD) 鍍霧銀 Matt silver (EL)

(mm)

Order No. 編號 (CI)	A	B	C	D	E	F
6010 - 32 - M 6	32	M6	21	12	10	12
- 40 - M 8	40	M8	26	15	13	14
- 50 - M 8	50	M8	34	18	17	18
- 50 - M10	50	M10	34	18	17	18
- 63 - M10	63	M10	42	22	21	20
- 63 - M12	63	M12	42	22	21	20
- 80 - M12	80	M12	52	28	25	25
- 80 - M16	80	M16	52	28	25	25

星型旋鈕 Hand Knobs

6011

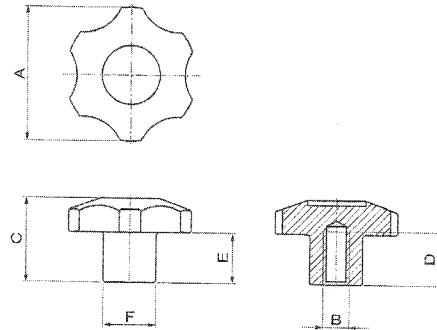

名稱 Name	材質 Material	表面處理 Surface process
本體 Base metal	鑄鐵 Cast iron (CI)	電鍍亮鎳 Chrome bright (CR)

(mm)

Order No. 編號 (CI)	A	B	C	D	E	F
6011 - 32 - M 6	32	M6	22	10	13	13
- 40 - M 8	40	M8	25	16	16	16
- 50 - M10	50	M10	32	20	20	20
- 63 - M12	63	M12	40	25	27	25
- 80 - M16	80	M16	50	32	32	32

[79]

星型旋鈕 Hand Knobs

6012

NEW

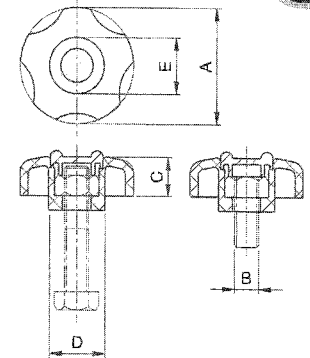
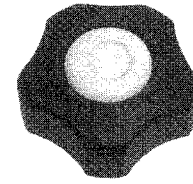

名稱 Name	材質 Material	表面處理 Surface process
旋鈕 Knob	尼龍加玻璃纖維 (KT)	黑色 Black
塑膠蓋顏色 Plastic cap color	尼龍加玻璃纖維 (KT)	黃色 Yellow (YE) 白色 White (WH)

(mm)

Order No. 尼龍加玻璃纖維 (KT)	A	B	C	D	E
6012 - 34 - M 6	34	M6	16	18	15
- 38 - M 8	38	M8	18	20	18
- 43 - M10	43	M10	22	22	21
- 53 - M12	53	M12	22	26	25

星型旋鈕 Hand Knobs

6020

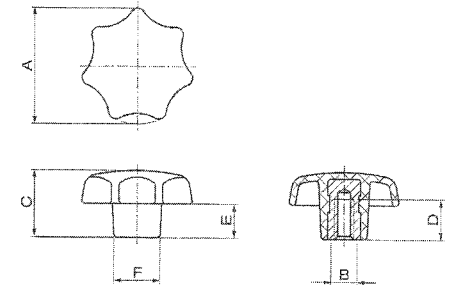

名稱 Name	材質 Material	表面處理 Surface process
旋鈕 Knob	尼龍加玻璃纖維 (KT)	黑色 Black
軸 Spindle	鋼質 Steel (ST)	鍍鋅 Zincing (ZI)

(mm)

Order No. 尼龍加玻璃纖維 (KT)	A	B	C	D	E	F
6020 - 20 - M 4	20	M4	13	6.5	7	10
- 25 - M 5	25	M5	16	9.5	8	12
- 25 - M 6	25	M6	16	9.5	8	12
- 32 - M 6	32	M6	20	12	10	14
- 40 - M 6	40	M6	25	14	13	18
- 40 - M 8	40	M8	25	14	13	18
- 50 - M 8	50	M8	32	18	17	22
- 50 - M10	50	M10	32	18	17	22
- 63 - M10	63	M10	40	22	21	26
- 63 - M12	63	M12	40	22	21	26
- 80 - M12	80	M12	50	22	25	35
- 80 - M16	80	M16	50	30	25	35

[80]

通孔星型旋鈕
Penetrated Hand Knobs

6025

NEW

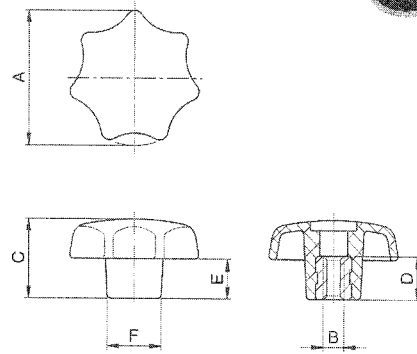
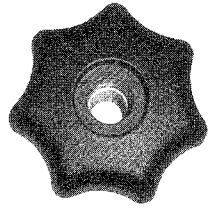

名稱	材質	表面處理
Name	Material	Surfaced process
旋鈕 Knob	尼龍加玻璃纖維 (KT)	黑色 Black
軸 Spindle	鋼鐵 Steel (ST)	鍍鋅 Zincing (ZI)

(mm)

Order No. 尼龍加玻璃纖維 (KT)	A	B	C	D	E	F
6025 - 32 - M 6	32	M6	20	9	10	14
- 40 - M 6	40	M6	25	12	13	18
- 40 - M 8	40	M8	25	12	13	18
- 50 - M10	50	M10	32	16	17	22
- 63 - M12	63	M12	39	21	21	26

星型旋鈕
Hand Knobs

6030

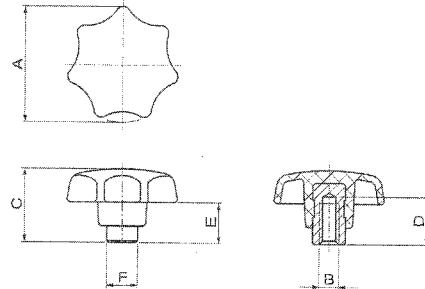
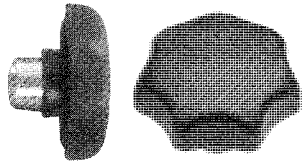

名稱	材質	表面處理
Name	Material	Surfaced process
旋鈕 Knob	尼龍加玻璃纖維 (KT)	黑色 Black
軸 Spindle	鋼鐵 Steel (ST)	鍍鋅 Zincing (ZI)

(mm)

Order No. 尼龍加玻璃纖維 (KT)	A	B	C	D	E	F
6030 - 32 - M 6	32	M6	21	12	10	12
- 40 - M 6	40	M6	26	14	13	14
- 40 - M 8	40	M8	26	14	13	14
- 50 - M 8	50	M8	34	18	17	18
- 50 - M10	50	M10	34	18	17	18
- 63 - M10	63	M10	42	22	21	20
- 63 - M12	63	M12	42	22	21	20
- 80 - M12	80	M12	52	30	27	25
- 80 - M16	80	M16	52	30	27	25

星型旋鈕
Hand Knobs

6035

NEW

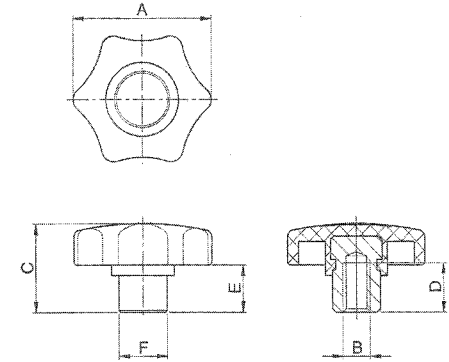
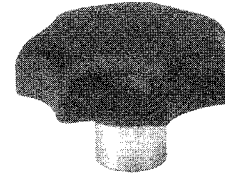

名稱	材質	表面處理
Name	Material	Surfaced process
旋鈕 Knob	尼龍加玻璃纖維 (KT)	黑色 Black
軸 Spindle	鋼鐵 Steel (ST)	鍍鋅 Zincing (ZI)

(mm)

Order No. 尼龍加玻璃纖維 (KT)	A	B	C	D	E	F
6035 - 40 - M 6	40	M6	25	14	13	14
40 - M 8	40	M8	25	14	13	14

不銹鋼星型旋鈕
ST. Steel Hand Knobs

6040

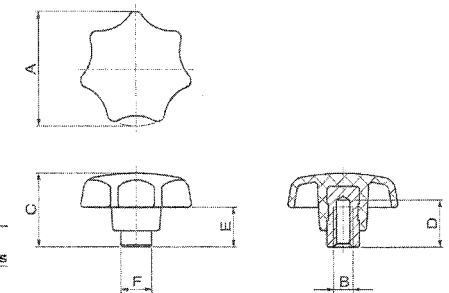
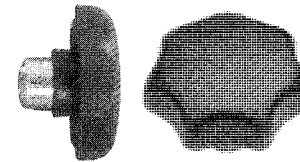

名稱	材質	表面處理
Name	Material	Surfaced process
旋鈕 Knob	尼龍加玻璃纖維 (KT)	黑色 Black
軸 Spindle	不銹鋼 Stainless steel (SST)	

(mm)

Order No. 尼龍加玻璃纖維 (KT)	A	B	C	D	E	F
6040 - 32 - M 6	32	M6	21	12	10	12
- 40 - M 8	40	M8	26	14	13	14
- 50 - M10	50	M10	34	18	17	18
- 63 - M12	63	M12	42	22	21	20
- 80 - M16	80	M16	52	30	27	25

不銹鋼星型旋鈕
ST. Steel Hand Knobs

6045

NEW

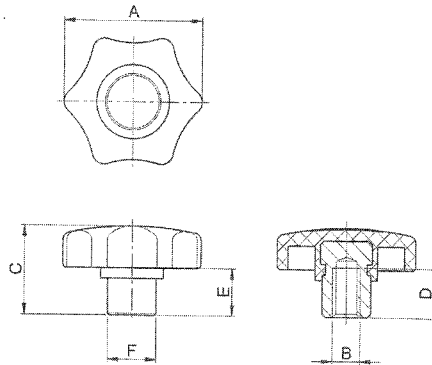
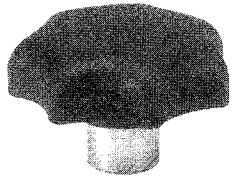

名稱 Name	材質 Material	表面處理 Surface process
旋鈕 Knob	尼龍加玻璃纖維 (KT)	黑色 Black
軸 Spindle	不銹鋼 Stainless steel (SST)	

(mm)

Order No. 尼龍加玻璃纖維 (KT)	A	B	C	D	E	F
6045 - 40 - M6	40	M6	25	14	13	14
- 40 - M8	40	M8	25	14	13	14

星型旋鈕
Hand Knobs

6050

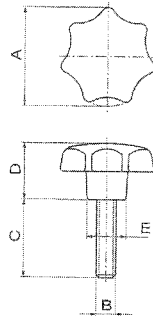
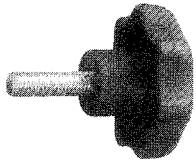

名稱 Name	材質 Material	表面處理 Surface process
旋鈕 Knob	尼龍加玻璃纖維 (KT)	黑色 Black
軸 Spindle	鋼鐵 Steel (ST)	鍍鋅 Zincing (ZI)

(mm)

Order No. 尼龍加玻璃纖維 (KT)	A	B	C								D	E
6050 - A - B - C	25	M5	10	15	20	30	-	-	-	-	16	12
	25	M6	10	15	20	30	-	-	-	-	16	12
	32	M6	10	15	20	30	40	-	-	-	20	14
	40	M6	-	15	20	30	40	50	-	-	25	18
	40	M8	-	15	20	30	40	50	-	-	25	18
	50	M8	-	15	20	30	40	50	60	-	32	22
	50	M10	-	-	20	30	40	50	60	-	32	22
	63	M10	-	-	20	30	40	50	60	-	40	26
	63	M12	-	-	20	30	40	50	60	-	40	26
	80	M12	-	-	20	30	40	50	60	80	50	35
	80	M16	-	-	-	-	40	50	60	80	50	35

不銹鋼星型旋鈕
ST. Steel Hand Knobs

6060

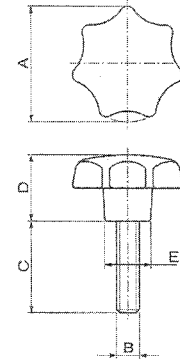
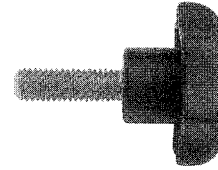

名稱 Name	材質 Material	表面處理 Surface process
旋鈕 Knob	尼龍加玻璃纖維 (KT)	黑色 Black
軸 Spindle	不銹鋼 Stainless steel (SST)	

(mm)

Order No. 尼龍加玻璃纖維 (KT)	A	B	C								D	E
6060 - A - B - C	32	M6	10	20	30	40	-	-	-	20	14	
	40	M8	-	20	30	40	50	-	-	25	18	
	50	M10	-	-	30	40	50	60	-	32	22	
	63	M12	-	-	30	40	50	60	-	40	26	
	80	M16	-	-	-	40	50	60	80	50	35	

星型快速螺帽
Quick Release Hand Knobs

6070

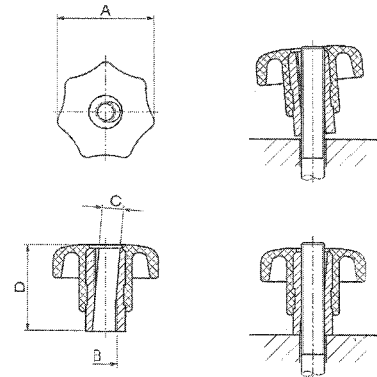
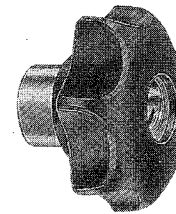

名稱 Name	材質 Material	表面處理 Surface process
旋鈕 Knob	尼龍加玻璃纖維 (KT)	黑色 Black
軸 Spindle	鋼鐵 Steel (ST)	鍍鋅 Zincing (ZI)

(mm)

Order No. 尼龍加玻璃纖維 (KT)	A	B	C	D
6070 - 40 - M8	40	M8	8.4	26
- 50 - M10	50	M10	10.5	34
- 63 - M12	63	M12	13	42

十字型旋鈕 Star Knobs

6080

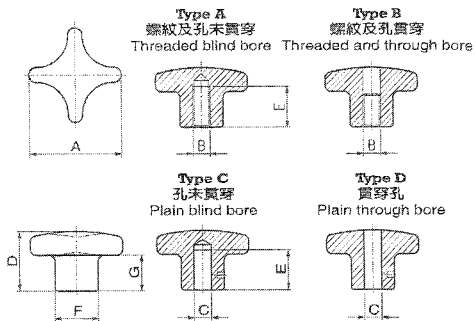
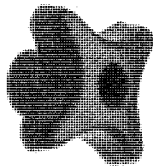

名稱 Name	材質 Material	表面處理 Surfaced process
旋鈕 Knob	鑄鐵 Cast iron (CI)	黑色烤漆 Paint black (BK) 紅色烤漆 Paint red (RD) 銀色烤漆 Paint silver (SR) 黃色烤漆 Paint yellow (YE)

(mm)

Order No.							A	B	C	D	E	F	G
Type A	Type B	Type C	Type D	A	B	C	D	E	F	G			
6080 - 32 - M 6	6081 - 32 - M 6	6082 - 32 - B 6	6083 - 32 - B 6	32	M6	B6	21	12	12	10			
- 40 - M 8	- 40 - M 8	- 40 - B 8	- 40 - B 8	40	M8	B8	26	15	14	14			
- 50 - M10	- 50 - M10	- 50 - B10	- 50 - B10	50	M10	B10	34	18	16	20			
- 63 - M12	- 63 - M12	- 63 - B12	- 63 - B12	63	M12	B12	42	22	20	25			
- 80 - M16	- 80 - M16	- 80 - B16	- 80 - B16	80	M16	B16	52	28	25	30			
- 100 - M20	- 100 - M20	- 100 - B20	- 100 - B20	100	M20	B20	65	36	32	38			

十字型旋鈕 Star Knobs

6100

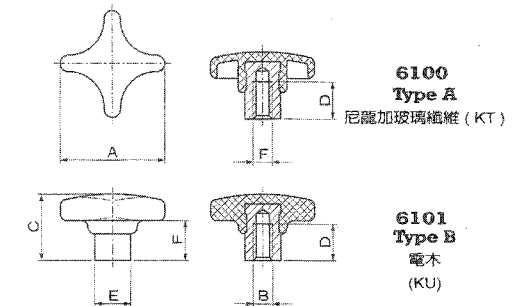

名稱 Name	材質 Material	表面處理 Surfaced process
旋鈕 Knob	尼龍加玻璃纖維 (KT) 電木 Bakelit (KU)	黑色 Black
軸 Spindle	鋼鐵 Steel (ST)	鍍鋅 Zincing (ZI)

(mm)

Order No. Type A (KT)	Order No. Type B (KU)	A	B	C	D	E	F
6100 - 32 - M 6	6101 - 32 - M 6	32	M6	20	12	12	10
- 40 - M 6	- 40 - M 6	40	M6	25	14	14	13
- 40 - M 8	- 40 - M 8	40	M8	25	14	14	13
- 50 - M 8	- 50 - M 8	50	M8	32	18	18	20
- 50 - M10	- 50 - M10	50	M10	32	18	18	20
- 63 - M10	- 63 - M10	63	M10	40	22	20	25
- 63 - M12	- 63 - M12	63	M12	40	22	20	25
- 80 - M12	- 80 - M12	80	M12	50	30	25	30
- 80 - M16	- 80 - M16	80	M16	50	30	25	30

十字型旋鈕 Star Knobs

6090

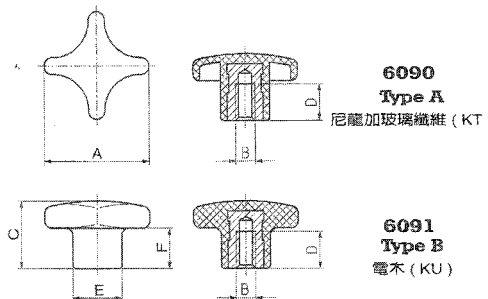
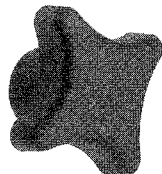

名稱 Name	材質 Material	表面處理 Surfaced process
旋鈕 Knob	尼龍加玻璃纖維 (KT)	黑色 Black
軸 Spindle	鋼鐵 Steel (ST)	鍍鋅 Zincing (ZI)

(mm)

Order No. Type A (KT)	Order No. Type B (KU)	A	B	C	D	E	F
—	6091 - 20 - M 4	20	M4	12	7	10	6
—	- 25 - M 5	25	M5	16	10	13	8
6090 - 32 - M 6	- 32 - M 6	32	M6	20	12	14	10
- 40 - M 8	- 40 - M 8	40	M8	25	14	18	13
- 50 - M10	- 50 - M10	50	M10	32	18	22	20
- 63 - M12	- 63 - M12	63	M12	40	22	26	25
- 80 - M16	- 80 - M16	80	M16	50	30	34	30
—	- 100 - M20	100	M20	65	30	35	38

十字型旋鈕 Star Knobs

6110

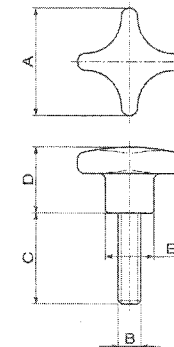
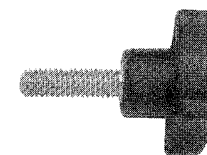

名稱 Name	材質 Material	表面處理 Surfaced process
旋鈕 Knob	尼龍加玻璃纖維 (KT) 電木 Bakelit (KU)	黑色 Black
軸 Spindle	鋼鐵 Steel (ST)	鍍鋅 Zincing (ZI)

(mm)

Order No. 尼龍加玻璃纖維 (KT)	Order No. 電木 (KU)	A	B	C	D	E					
6110 - A - B - C	6111 - A - B - C	32	M6	10	20	25	30	40	—	20	14
—	—	40	M8	20	25	30	40	50	—	25	18
—	—	50	M10	25	30	40	50	60	—	32	22
—	—	63	M12	30	40	50	60	70	—	40	26
—	—	80	M16	30	40	50	60	70	80	50	35

不銹鋼星型旋鈕 ST. Steel Hand Knobs

6120

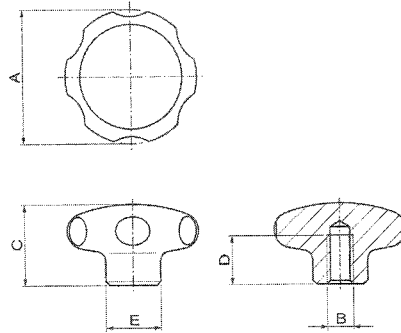

名稱	材質
Name	Material
旋鈕 Knob	不銹鋼 Stainless steel (SST)

(mm)

Order No. 不銹鋼 (SST)	A	B	C	D	E
6120 - 40 - M 6	40	M6	27	12	18
- 50 - M 8	50	M8	29	15	21
- 60 - M10	60	M10	33	18	26

星型旋鈕 Hand Knobs

6130

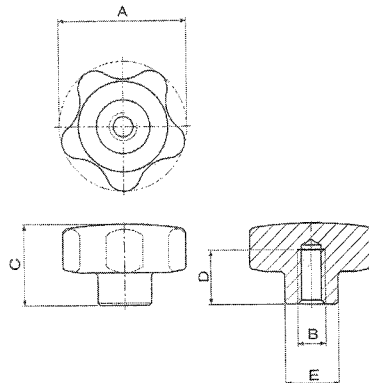
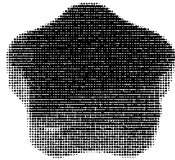

名稱	材質	表面處理
Name	Material	Surfaced process
旋鈕 Knob	鋁合金 Aluminum (AL)	電鍍黑色 Matt black (B)

(mm)

Order No. 鋁合金 (AL)	A	B	C	D	E
6130 - 40 - M 6	40	M6	25	15	15
- 50 - M 8	50	M8	32	18	19
- 60 - M 8	60	M8	37	25	25
- 60 - M10	60	M10	37	25	25
- 70 - M12	70	M12	46	28	26

電木星型旋鈕 Bakelite Hand Knobs

6200

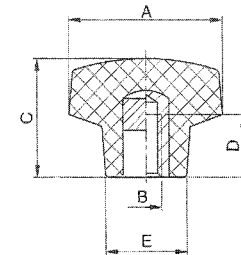

名稱	材質	表面處理
Name	Material	Surfaced process
旋鈕 Knob	電木 Bakelit (KU)	黑色 Black
軸 Spindle	銅 Capper (CU)	

(mm)

Order No. 電木 (KU)	A	B	C	D	E
6200 - 20 - M 4	20	M4	15	9	13
- 20 - M 5	20	M5	15	9	13
- 20 - M 6	20	M6	15	9	13
- 30 - M 5	30	M5	24	9	17
- 30 - M 6	30	M6	24	9	17
- 30 - M 8	30	M8	24	15	17
- 40 - M 6	40	M6	28	13	21
- 40 - M 8	40	M8	28	15	21
- 40 - M10	40	M10	28	16	21
- 50 - M 8	50	M8	33	15	25
- 50 - M10	50	M10	33	16	25
- 50 - M12	50	M12	33	18	25

電木星型旋鈕 Bakelite Hand Knobs

6201

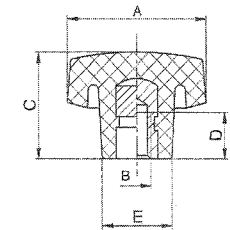

名稱	材質	表面處理
Name	Material	Surfaced process
旋鈕 Knob	電木 Bakelit (KU)	黑色 Black
軸 Spindle	銅 Capper (CU)	

(mm)

Order No. 電木 (KU)	A	B	C	D	E
6201 - 40 - M 6	40	M6	28	13	21
- 40 - M 8	40	M8	28	15	21
- 40 - M10	40	M10	28	16	21
- 50 - M 8	50	M8	33	15	25
- 50 - M10	50	M10	33	16	25
- 50 - M12	50	M12	33	18	25
- 60 - M 8	60	M8	36	15	28
- 60 - M10	60	M10	35	16	28
- 60 - M12	60	M12	35	18	28
- 60 - M14	60	M14	35	20	28
- 60 - M16	60	M16	35	20	28
- 70 - M10	70	M10	42	16	32
- 70 - M12	70	M12	42	18	32
- 70 - M14	70	M14	42	20	32
- 70 - M16	70	M16	42	20	32
- 90 - M12	90	M12	55	18	42
- 90 - M14	90	M14	55	20	42
- 90 - M16	90	M16	55	20	42
- 90 - M18	90	M18	55	20	42

電木通孔星型旋鈕
Bakelite Penetrated Hand Knobs

6210

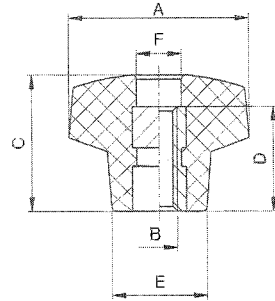
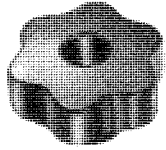

名稱 Name	材質 Material	表面處理 Surfaced process
旋鈕 Knob	電木 Bakelit (KU)	黑色 Black
軸 Spindle	銅 Capper (CU)	

(mm)

Order No. 電木 (KU)	A	B	C	D	E	F
6210 - 20 - M4	20	M4	15	8	13	5
- 20 - M5	20	M5	15	8	13	6
- 20 - M6	20	M6	15	8	13	7
- 30 - M5	30	M5	24	15	17	9
- 30 - M6	30	M6	24	15	17	9
- 30 - M8	30	M8	24	15	17	9

電木通孔星型旋鈕
Bakelite Penetrated Hand Knobs

6211

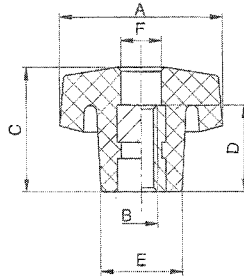
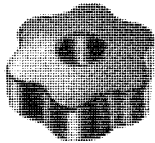

名稱 Name	材質 Material	表面處理 Surfaced process
旋鈕 Knob	電木 Bakelit (KU)	黑色 Black
軸 Spindle	銅 Capper (CU)	

(mm)

Order No. 電木 (KU)	A	B	C	D	E	F
6211 - 40 - M6	40	M6	28	18	21	11
- 40 - M8	40	M8	28	18	21	11
- 40 - M10	40	M10	28	18	21	11
- 50 - M8	50	M8	33	18	25	13
- 50 - M10	50	M10	33	18	25	13
- 50 - M12	50	M12	33	18	25	13
- 60 - M10	60	M10	35	25	28	11
- 60 - M12	60	M12	35	25	28	13
- 60 - M14	60	M14	35	25	28	15
- 60 - M16	60	M16	35	25	28	17
- 70 - M10	70	M10	42	25	32	11
- 70 - M12	70	M12	42	25	32	13
- 70 - M14	70	M14	42	25	32	15
- 70 - M16	70	M16	42	25	32	17

塑膠星型旋鈕
Plastic Hand Knobs

6220

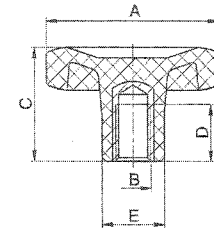

名稱 Name	材質 Material	表面處理 Surfaced process
旋鈕 Knob	尼龍加玻璃纖維 (KT)	黑色 Black
軸 Spindle	銅 Capper (CU)	

(mm)

Order No. 尼龍加玻璃纖維 (KT)	A	B	C	D	E
6220 - 20 - M4	20	M4	20	9	11
- 20 - M5	20	M5	20	9	11
- 20 - M6	20	M6	20	9	11
- 30 - M5	30	M5	24	13	14
- 30 - M6	30	M6	24	13	14
- 30 - M8	30	M8	24	13	14
- 40 - M6	40	M6	28	13	16
- 40 - M8	40	M8	28	13	16
- 40 - M10	40	M10	28	13	16
- 50 - M8	50	M8	32	16	18
- 50 - M10	50	M10	32	16	18
- 60 - M8	60	M8	36	15	20
- 60 - M10	60	M10	36	15	20
- 60 - M12	60	M12	36	18	20
- 70 - M10	70	M10	40	16	23
- 70 - M12	70	M12	40	16	23
- 70 - M14	70	M14	40	20	23
- 70 - M16	70	M16	40	20	23

塑膠星型旋鈕
Plastic Hand Knobs

6221

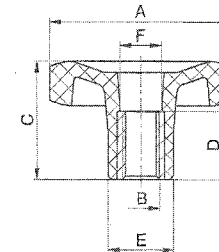

名稱 Name	材質 Material	表面處理 Surfaced process
旋鈕 Knob	尼龍加玻璃纖維 (KT)	黑色 Black
軸 Spindle	銅 Capper (CU)	

(mm)

Order No. 尼龍加玻璃纖維 (KT)	A	B	C	D	E	F
6221 - 20 - M4	20	M4	20	11	11	7
- 20 - M5	20	M5	20	11	11	7
- 20 - M6	20	M6	20	11	11	7
- 30 - M5	30	M5	24	11	14	8
- 30 - M6	30	M6	24	11	14	8
- 30 - M8	30	M8	24	11	14	8
- 40 - M6	40	M6	28	15	16	7
- 40 - M8	40	M8	28	15	16	11
- 40 - M10	40	M10	28	15	16	11
- 50 - M8	50	M8	32	18	18	11
- 50 - M10	50	M10	32	18	18	11
- 60 - M10	60	M10	36	25	20	13
- 60 - M12	60	M12	36	25	20	13
- 70 - M12	70	M12	40	25	23	14
- 70 - M14	70	M14	40	25	23	16
- 70 - M16	70	M16	40	25	23	17

塑膠星型旋鈕 Plastic Hand Knobs

6230

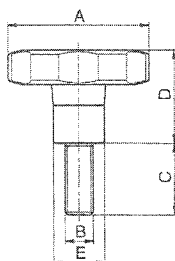
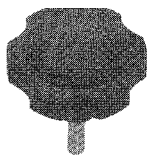

名稱 Name	材質 Material	表面處理 Surfaced process
旋鈕 Knob	尼龍加玻璃纖維 (KT)	黑色 Black

(mm)

Order No. 尼龍加玻璃纖維 (KT)	A	B	C					D	E	
6230 - A - B - C 螺紋長度 Thread length 外螺紋 External thread 旋鈕外徑 Knobs diameter	20	M4	10	15	--	--	--	20	11	
	20	M5	15	20	25	--	--	20	11	
	20	M6	10	15	20	--	--	20	11	
	30	M6	15	20	25	30	40	24	14	
	30	M8	15	20	25	30	35	24	14	
	40	M6	20	30	40	--	--	28	16	
	40	M8	15	20	25	30	40	50	28	16
	50	M8	15	20	25	30	40	60	32	18
	50	M10	20	30	40	50	--	32	18	
	60	M8	30	--	--	--	--	36	20	
	60	M10	30	40	50	--	--	36	20	
	60	M12	30	40	50	--	--	36	20	
	70	M10	30	--	--	--	--	40	23	
	70	M12	30	40	50	--	--	40	23	

塑膠星型旋鈕 Plastic Hand Knobs

6240

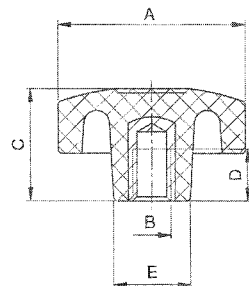

名稱 Name	材質 Material	表面處理 Surfaced process
旋鈕 Knob	尼龍加玻璃纖維 (KT)	黑色 Black
軸 Spindle	銅 Capper (CU)	

(mm)

Order No. 尼龍加玻璃纖維 (KT)	A	B	C					D	E
6240 - 25 - M 4 螺紋長度 Thread length 外螺紋 External thread 旋鈕外徑 Knobs diameter	25	M4	10	15	--	--	--	17	13
	25	M5	10	15	20	25	30	17	13
	25	M6	10	15	20	25	30	17	13
	35	M6	15	20	25	30	35	18	13
	35	M8	15	20	25	30	35	18	13
	45	M5	20	25	30	35	40	22	18
	45	M6	20	25	30	35	40	22	18
	45	M8	20	25	30	35	40	22	18
	45	M10	20	25	30	35	40	22	18
	55	M8	25	30	35	40	45	25	20
	55	M10	25	30	35	40	45	25	20
	55	M12	25	30	35	40	45	25	20

塑膠星型旋鈕 Plastic Hand Knobs

6241

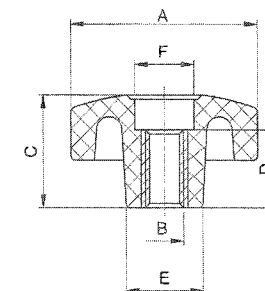

名稱 Name	材質 Material	表面處理 Surfaced process
旋鈕 Knob	尼龍加玻璃纖維 (KT)	黑色 Black
軸 Spindle	銅 Capper (CU)	

(mm)

Order No. 尼龍加玻璃纖維 (KT)	A	B	C					D	E	F
6241 - 25 - M 4 螺紋長度 Thread length 外螺紋 External thread 旋鈕外徑 Knobs diameter	25	M4	10	15	--	--	--	11	11	7
	25	M5	10	15	20	25	30	11	11	7
	25	M6	10	15	20	25	30	11	11	7
	35	M5	15	20	25	30	35	15	18	11
	35	M6	15	20	25	30	35	15	18	11
	35	M8	15	20	25	30	35	15	18	11
	45	M6	20	25	30	35	40	18	22	11
	45	M8	20	25	30	35	40	18	22	11
	45	M10	20	25	30	35	40	18	22	11
	55	M8	25	30	35	40	45	18	25	13
	55	M10	25	30	35	40	45	18	25	13
	55	M12	25	30	35	40	45	18	25	13

塑膠星型旋鈕 Plastic Hand Knobs

6250

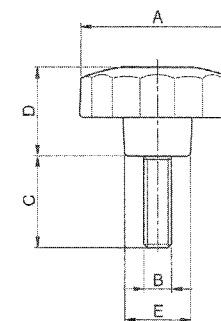
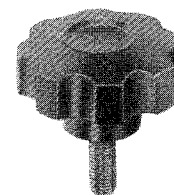

名稱 Name	材質 Material	表面處理 Surfaced process
旋鈕 Knob	尼龍加玻璃纖維 (KT)	黑色 Black
軸 Spindle	銅 Capper (CU)	

(mm)

Order No. 尼龍加玻璃纖維 (KT)	A	B	C					D	E
6250 - A - B - C 螺紋長度 Thread length 外螺紋 External thread 旋鈕外徑 Knobs diameter	25	M4	10	15	--	--	--	17	13
	25	M5	10	15	20	25	30	17	13
	25	M6	10	15	20	25	30	17	13
	35	M6	15	20	25	30	35	20	18
	35	M8	15	20	25	30	35	20	18
	35	M10	15	20	25	30	35	20	18
	45	M8	20	25	30	35	40	26	22
	45	M10	20	25	30	35	40	26	22
	55	M8	25	30	35	40	45	29	25
	55	M10	25	30	35	40	45	29	25
	55	M12	25	30	35	40	45	29	25

塑膠三幅旋鈕 Plastic Three Lobe Knobs

6260



名稱 Name	材質 Material	塑膠蓋顏色 Plastic cap color
旋鈕 Knob	尼龍加玻璃纖維 (KT)	黑色 Black (BK)
	銅 Copper (CU)	紅色 Red (RD)
		橘色 Orange (OR)
		藍色 Blue (BL)
		灰色 Gray (GR)
		黃色 Yellow (YE)

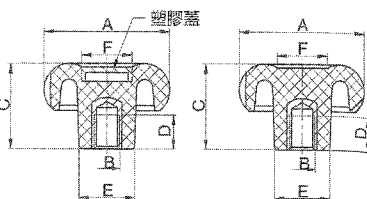

(mm)

Order No. 尼龍加玻璃纖維 (KT)	A	B	C	D	E	F
6260 - 20 - M 4	20	M4	18	9	12	8
- 20 - M 5	20	M5	18	9	12	8
- 20 - M 6	20	M6	18	9	12	8
- 30 - M 5	30	M5	22	9	14	8
- 30 - M 6	30	M6	22	9	14	11
- 30 - M 8	30	M8	22	9	14	11
- 40 - M 6	40	M6	28	13	18	15
- 40 - M 8	40	M8	28	13	18	15
- 40 - M 10	40	M10	28	13	18	15
- 50 - M 8	50	M8	33	16	22	20
- 50 - M 10	50	M10	33	16	22	20
- 50 - M 12	50	M12	33	16	22	25
- 60 - M 10	60	M10	39	16	26	25
- 60 - M 12	60	M12	39	18	26	25
- 70 - M 12	70	M12	44	18	30	30
- 70 - M 14	70	M14	44	20	30	30
- 70 - M 16	70	M16	44	20	30	30

塑膠三幅旋鈕 Plastic Three Lobe Knobs

6261



名稱 Name	材質 Material	表面處理 Surfaced process
旋鈕 Knob	尼龍加玻璃纖維 (KT)	黑色 Black
軸 Spindle	銅 Copper (CU)	

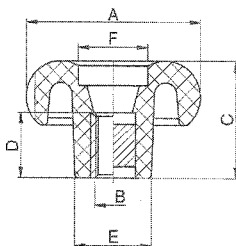
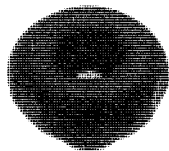

(mm)

Order No. 尼龍加玻璃纖維 (KT)	A	B	C	D	E	F
6261 - 20 - M 4	20	M4	18	11	12	8
- 20 - M 5	20	M5	18	11	12	8
- 20 - M 6	20	M6	18	11	12	8
- 30 - M 5	30	M5	22	11	14	8
- 30 - M 6	30	M6	22	11	14	11
- 30 - M 8	30	M8	22	11	14	11
- 40 - M 6	40	M6	28	15	18	15
- 40 - M 8	40	M8	28	15	18	15
- 40 - M 10	40	M10	28	15	18	15
- 50 - M 8	50	M8	33	18	22	20
- 50 - M 10	50	M10	33	18	22	20
- 50 - M 12	50	M12	33	18	22	25
- 60 - M 10	60	M10	39	18	26	25
- 60 - M 12	60	M12	39	25	26	25
- 70 - M 12	70	M12	44	25	30	30
- 70 - M 14	70	M14	44	25	30	30
- 70 - M 16	70	M16	44	25	30	30

塑膠三幅旋鈕 Plastic Three Lobe Knobs

6270



名稱 Name	材質 Material	塑膠蓋顏色 Plastic cap color
旋鈕 Knob	尼龍加玻璃纖維 (KT)	黑色 Black (BK)
		紅色 Red (RD)
		橘色 Orange (OR)
		藍色 Blue (BL)
		灰色 Gray (GR)
		黃色 Yellow (YE)

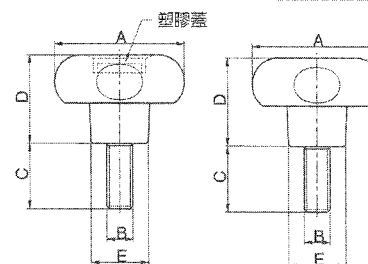

(mm)

Order No. 尼龍加玻璃纖維 (KT)	A	B	C				D	E
6270 - A - B - C	20	M4	10	15	-	-	18	12
	20	M5	10	15	20	25	18	12
	20	M6	10	15	20	25	18	12
	30	M5	15	20	-	-	22	14
	30	M6	15	20	25	30	22	14
	30	M8	15	20	25	30	22	14
	40	M6	20	30	40	-	28	18
	40	M8	15	20	25	30	28	18
	40	M10	20	30	-	-	28	18
	50	M8	15	20	40	60	33	22
	50	M10	20	30	40	-	33	22
	50	M12	30	40	-	-	33	22
	60	M10	20	30	40	50	39	26
	60	M12	30	40	50	60	39	26
	70	M12	30	40	50	-	44	30
	70	M14	40	50	-	-	44	30

塑膠旋鈕 Plastic Knobs

6280



名稱 Name	材質 Material	表面處理 Surfaced process
旋鈕 Knob	尼龍加玻璃纖維 Bakelit (KT)	黑色 Black

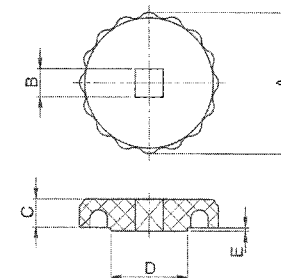
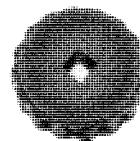

(mm)

Order No. 尼龍加玻璃纖維 (KT)	A	B	C	D	E
6280 - 40 - M 5	40	M5	10	10	10
- 40 - M 6	40	M6	10	10	10

塑膠旋鈕
Plastic Knobs

6290

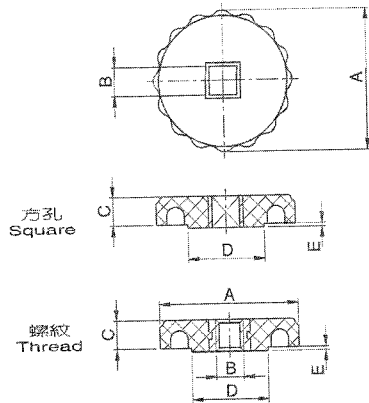
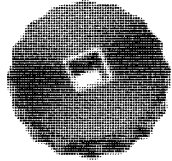

名稱	材質	表面處理
Name	Material	Surfaced process
旋鈕 Knob	尼龍加玻璃纖維 (KT)	黑色 Black
軸 Spindle	銅 Capper (CU)	

(mm)

Order No. 尼龍加玻璃纖維 (KT)		A	B	C	D	E
方孔 Square	6290 - 40 - V 6	40	V6	8	20	1
	- 40 - V 8	40	V8	8	20	1
螺紋 Thread	- 40 - M 8	40	M8	8	20	1
	- 40 - M10	40	M10	8	20	1

電木三角型旋鈕
Bakelite Three Lobe Knobs

6300

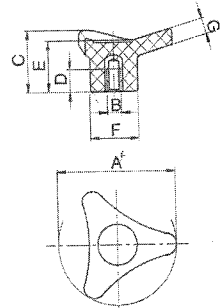
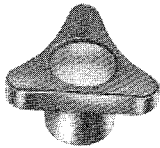

名稱	材質	表面處理
Name	Material	Surfaced process
旋鈕 Knob	電木 Bakelit (KU)	黑色 Black
軸 Spindle	銅 Capper (CU)	

(mm)

Order No. 電木 (KU)		A	B	C	D	E	F	G
6300	34 - M 5	34	M5	22	9	20	17	7
	34 - M 6	34	M6	22	9	20	17	7
	34 - M 8	34	M8	22	9	20	17	7
	45 - M 6	45	M6	30	15	27	25	8.5
	45 - M 8	45	M8	30	15	27	25	8.5
	45 - M10	45	M10	30	15	27	25	8.5
	65 - M 8	65	M8	39	18	36	30	10
	65 - M10	65	M10	39	18	36	30	10
	65 - M12	65	M12	39	18	36	30	10
	85 - M 8	85	M8	48	18	43	35	12
	85 - M10	85	M10	48	18	43	35	12
	85 - M12	85	M12	48	18	43	35	12
	85 - M16	85	M16	48	20	43	35	12

電木三角型旋鈕
Bakelite Three Lobe Knobs

6310

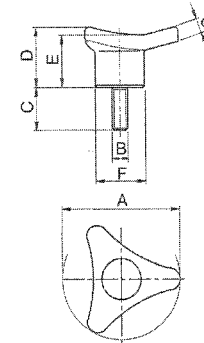
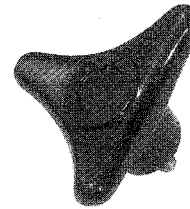

名稱	材質	表面處理
Name	Material	Surfaced process
旋鈕 Knob	電木 (KU)	黑色 Black
軸 Spindle	鋼鐵 Steel (ST)	

(mm)

Order No. 電木 (KU)		A	B	C	D	E	F	G
6310 - A - B - C		34	M6	15	20	25	30	22
		34	M8	15	20	25	30	22
		45	M8	20	30	40	30	27
		45	M10	30	—	—	30	27
		65	M8	40	—	—	39	36
		65	M10	30	—	—	39	36
		85	M10	15	—	—	48	43
		85	M12	20	35	—	48	43

螺紋長度 Thread length
外螺紋 External thread
旋鈕外徑 Knobs diameter

塑膠三角型旋鈕
Plastic Three Lobe Knobs

6320

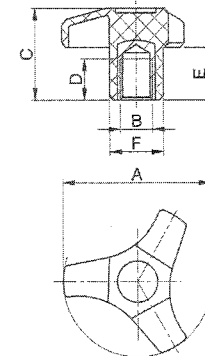
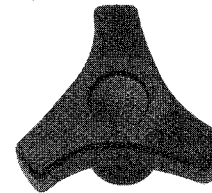

名稱	材質	表面處理
Name	Material	Surfaced process
旋鈕 Knob	尼龍加玻璃纖維 (KT)	黑色 Black
軸 Spindle	銅 Capper (CU)	

(mm)

Order No. 尼龍加玻璃纖維 (KT)		A	B	C	D	E	F
6320	45 - M 6	45	M6	27	14	16	18
	- 45 - M 8	45	M8	27	14	16	18
	- 45 - M10	45	M10	27	14	16	18
	- 55 - M 8	55	M8	33	14	19	20
	- 55 - M10	55	M10	33	14	19	20
	- 55 - M12	55	M12	33	14	19	20

塑膠三角型旋鈕
Plastic Three Lobe Knobs

6321

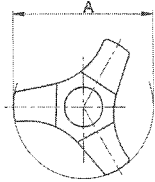
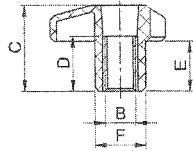
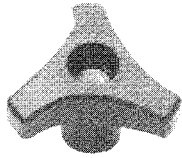

名稱 Name	材質 Material	表面處理 Surfaced process
旋鈕 Knob	尼龍加玻璃纖維 (KT)	黑色 Black
軸 Spindle	銅 Capper (CU)	

(mm)

Order No. 尼龍加玻璃纖維 (KT)	A	B	C	D	E	F
6321 - 45 - M 6	45	M6	27	15	16	18
- 45 - M 8	45	M8	27	15	16	18
- 45 - M10	45	M10	27	15	16	18
- 55 - M 8	55	M8	33	15	19	20
- 55 - M10	55	M10	33	15	19	20
- 55 - M12	55	M12	33	15	19	20

塑膠三角型旋鈕
Plastic Three Lobe Knobs

6335

NEW

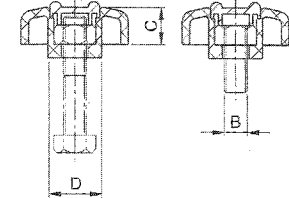
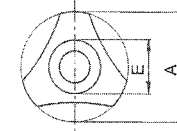

名稱 Name	材質 Material	表面處理 Surfaced process
旋鈕 Knob	尼龍加玻璃纖維 (KT)	黑色 Black
塑膠蓋顏色 Plastic cap color	白色 White (WH) 黃色 Yellow (YE)	

(mm)

Order No. 尼龍加玻璃纖維 (KT)	A	B	C	D	E
6335 - 37 - M 6	37	M6	16	16	15
- 42 - M 8	42	M8	19	20	18
- 47 - M10	47	M10	23	23	21

塑膠三角型旋鈕
Plastic Three Lobe Knobs

6330

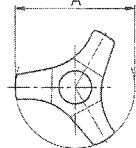
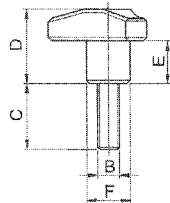
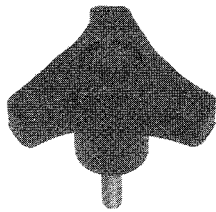

名稱 Name	材質 Material	表面處理 Surfaced process
旋鈕 Knob	尼龍加玻璃纖維 (KT)	黑色 Black
軸 Spindle	鋼鐵 Steel (ST)	

(mm)

Order No. 尼龍加玻璃纖維 (KT)	A	B	C	D	E	F
6330 - A - B - C	45	M6	15	20	25	30
	45	M8	15	20	25	30
	45	M10	15	20	25	30
	55	M6	15	20	25	30
	55	M8	15	20	25	30
	55	M10	15	20	25	30

螺紋長度 Thread length
 外螺紋 External thread
 旋鈕外徑 Knobs diameter

電木星型旋鈕
Bakelite Hand Knobs

6340

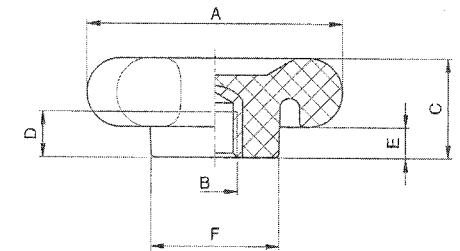
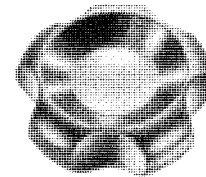

名稱 Name	材質 Material	表面處理 Surfaced process
旋鈕 Knob	電木 Bakelit (KU)	黑色 Black
軸 Spindle	銅 Capper (CU)	

(mm)

Order No. 電木 (KU)	A	B	C	D	E	F
6340 - 75 - M10	75	M10	28	13	8	34
- 75 - M12	75	M12	26	13	8	34

電木星型旋鈕
Bakelite Hand Knobs

6341

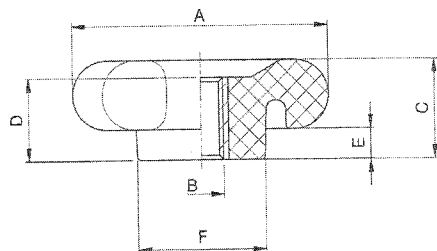
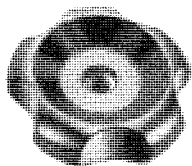

名稱 Name	材質 Material	表面處理 Surfaced process
旋鈕 Knob	電木 Bakelit (KU)	黑色 Black
軸 Spindle	銅 Capper (CU)	

(mm)

Order No. 電木 (KU)	A	B	C	D	E	F
6341 - 75 - M10	75	M10	28	21	8	34

電木星型旋鈕
Bakelite Hand Knobs

6350

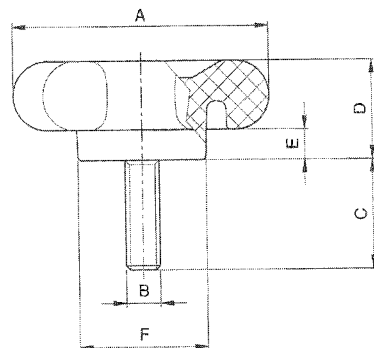
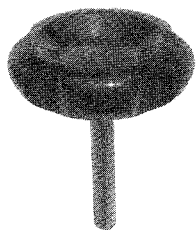

名稱 Name	材質 Material	表面處理 Surfaced process
旋鈕 Knob	電木 Bakelit (KU)	黑色 Black
軸 Spindle	鋼鐵 Steel (ST)	

(mm)

Order No. 電木 (KU)	A	B	C	D	E	F
6350 - 75 - M10	75	M10	60	28	8	34
- 75 - M12	75	M12	60	28	8	34

電木星型旋鈕
Bakelite Hand Knobs

6360

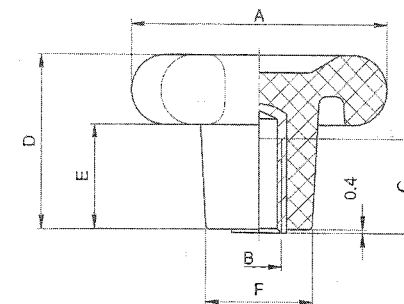
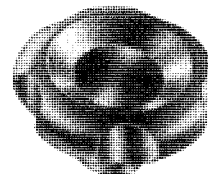

名稱 Name	材質 Material	表面處理 Surfaced process
旋鈕 Knob	電木 Bakelit (KU)	黑色 Black
軸 Spindle	鋼鐵 Steel (ST)	

(mm)

Order No. 電木 (KU)	A	B	C	D	E	F
6360 - 60 - M8	60	M8	18	40	24	25
- 60 - M10	60	M10	18	40	24	25
- 75 - M10	75	M10	21	48	28	30
- 75 - M12	75	M12	21	48	28	30
- 90 - M12	90	M12	21	52	32	35
- 90 - M14	90	M14	21	52	32	35

電木星型旋鈕
Bakelite Hand Knobs

6361

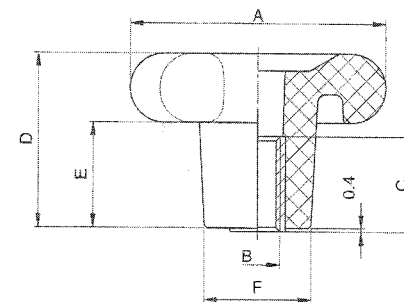
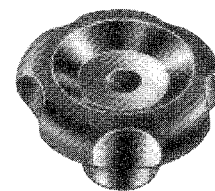

名稱 Name	材質 Material	表面處理 Surfaced process
旋鈕 Knob	電木 Bakelit (KU)	黑色 Black
軸 Spindle	銅 Capper (CU)	

(mm)

Order No. 電木 (KU)	A	B	C	D	E	F
6361 - 75 - M10	75	M10	21	48	28	30
- 75 - M12	75	M12	21	48	28	30
- 90 - M12	90	M12	21	52	32	35
- 90 - M14	90	M14	21	52	32	35

電木星型旋鈕
Bakelite Hand Knobs

6370

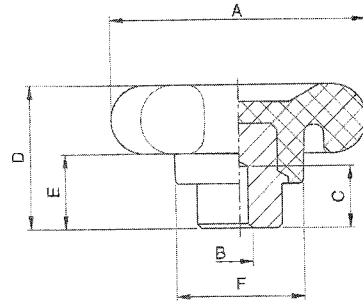
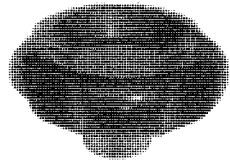

名稱 Name	材質 Material	表面處理 Surfaced process
旋鈕 Knob	電木 Bakelit (KU)	黑色 Black
軸 Spindle	鋼鐵 Steel (ST)	

(mm)

Order No. 電木 (KU)	A	B	C	D	E	F
6370 - 60 - B4	60	B4	15	32	16	30
- 75 - B4	75	B4	22	39	19	34
- 90 - B6	90	B6	25	42	22	44

電木星型旋鈕
Bakelite Hand Knobs

6375

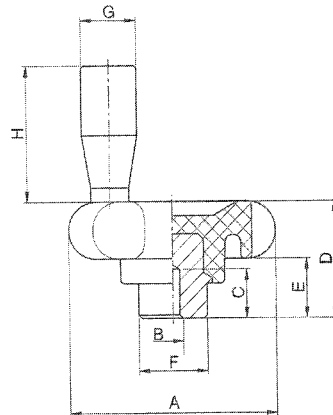
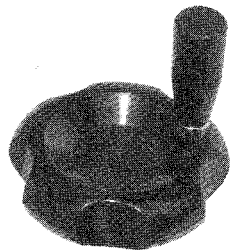

名稱 Name	材質 Material	表面處理 Surfaced process
旋鈕 Knob	電木 Bakelit (KU)	黑色 Black
軸 Spindle	鋼鐵 Steel (ST)	

(mm)

Order No. 電木 (KU)	A	B	C	D	E	F	G	H
6375 - 75 - B4	75	B4	32	38	19	24	17	43
- 90 - B6	90	B6	25	42	22	28	13	43

[101]

電木星型旋鈕
Bakelite Hand Knobs

6380

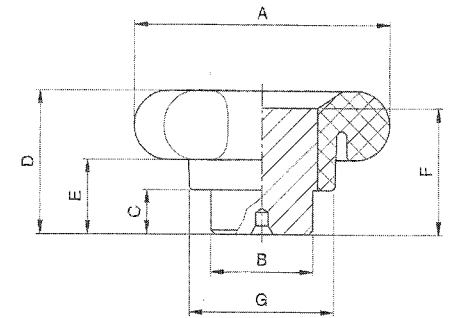
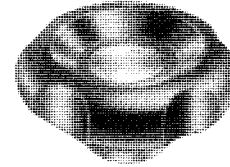

名稱 Name	材質 Material	表面處理 Surfaced process
旋鈕 Knob	電木 Bakelit (KU)	黑色 Black
軸 Spindle	鋼鐵 Steel (ST)	

(mm)

Order No. 電木 (KU)	A	B	C	D	E	F	G
6380 - 60 - B26	60	B26	10	32	16	26	34
- 75 - B32	75	B32	12	40	20	32.5	40
- 90 - B40	90	B40	14	44	24	36.7	47

電木星型旋鈕
Bakelite Hand Knobs

6390

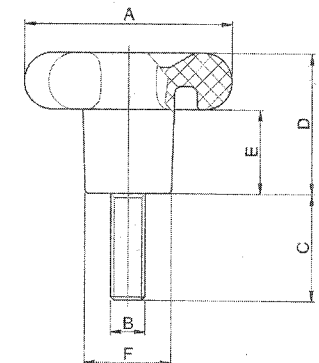
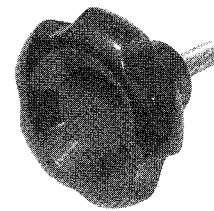

名稱 Name	材質 Material	表面處理 Surfaced process
旋鈕 Knob	電木 Bakelit (KU)	黑色 Black
軸 Spindle	鋼鐵 Steel (ST)	

(mm)

Order No. 電木 (KU)	A	B	C	D	E	F
6390 - A - B - C	60	M8	30	-	-	40
	60	M10	30	-	-	40
	75	M10	30	60	70	48
	75	M12	30	60	70	48
	90	M12	60	70	-	52
	90	M14	60	70	-	52

螺紋長度 Thread length
 外螺紋 External thread
 旋鈕外徑 Knobs diameter

[102]

刻度環 Scale Rings

7010

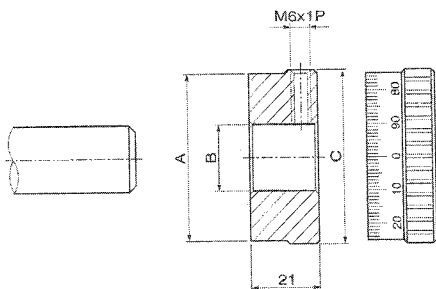
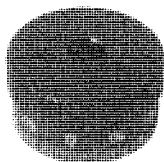

名稱 Name	材質 Material	表面處理 Surfaced process
本體 Base metal	鋁合金 Aluminum (AL)	電鍍黑色
刻字 Scale	白色 White	Matt black (B)

(mm)

Order No. 型號 (AL)	A	B	C
7010 - 25 - B 8	25	B8	27
- 32 - B12	32	B12	34
- 40 - B14	40	B14	42
- 50 - B16	50	B16	52
- 60 - B18	60	B18	62
- 70 - B20	70	B20	72
- 80 - B22	80	B22	82
- 100 - B24	100	B24	102

刻度環 Scale Rings

7011

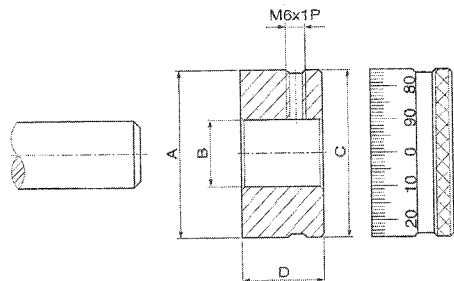
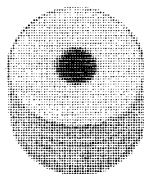

名稱 Name	材質 Material	表面處理 Surfaced process
本體 Base metal	鋼鐵 Steel (ST)	電鍍霧銀
刻字 Scale	黑色 Black	Matt silver (EL)

(mm)

Order No. 型號 (ST)	A	B	C	D
7011 - 25 - B 8	25	B8	25.3	25
- 37 - B10	37	B10	37.3	25
- 50 - B12	50	B12	50.5	25
- 60 - B15	60	B15	60.5	25
- 73 - B15	73	B15	73.5	25
- 83 - B15	83	B15	83.5	25
- 100 - B15	100	B15	100.6	25

[103]

控制旋鈕 Control Knobs

7020

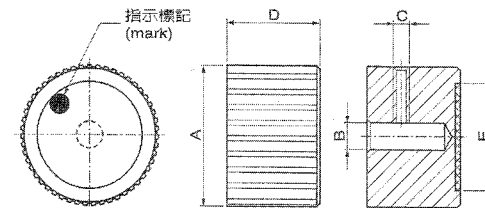

名稱 Name	材質 Material	表面處理 Surfaced process
旋鈕 Knobs	鋁合金 Aluminum (AL)	電鍍黑色
蓋子 Cap	鋁合金 Aluminum (AL)	Matt black (B)

7020 Type A	7021 Type B
有指示標記 With mark	無指示標記 Without mark

(mm)

Order No. 型號 Type A	Order No. 型號 Type B	A	B	C	D	E
7020 - 27 - B6	7021 - 27 - B6	27	B6	M4	17	18.3
- 34 - B6	- 34 - B6	34	B6	M5	20	26.1
- 42 - B8	- 42 - B8	42	B8	M5	23	32
- 52 - B8	- 52 - B8	52	B8	M5	25	39.1

控制旋鈕 Control Knobs

7030

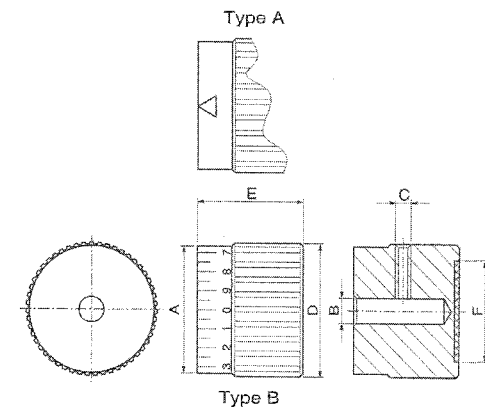

名稱 Name	材質 Material	表面處理 Surfaced process
旋鈕 Knobs	鋁合金 Aluminum (AL)	電鍍黑色
刻字 Scale	白色 White	Matt black (B)
蓋子 Cap	鋁合金 Aluminum (AL)	

7030 Type A	7031 Type B
箭頭 With arrow <	刻度比例尺 Scale 1°-9°, graduation

(mm)

Order No. 型號 Type A	Order No. 型號 Type B	A	B	C	D	E	L
7030 - 25 - B8	7031 - 25 - B8	25	B8	M4	27	25	18.3
- 32 - B8	- 32 - B8	32	B8	M4	34	30	26.1
- 42 - B8	- 42 - B8	42	B8	M4	42	34	32
- 50 - B8	- 50 - B8	50	B8	M4	52	38	39.1

[104]

控制旋鈕 Control Knobs

7040

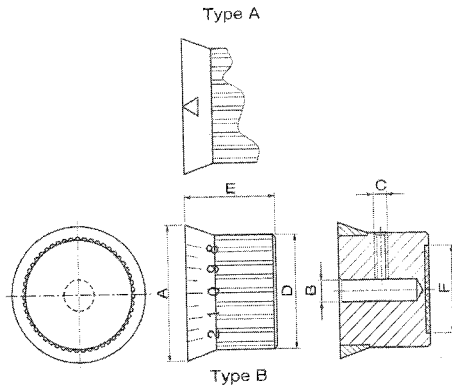
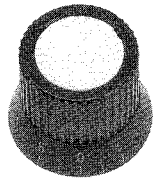

名稱 Name	材質 Material	表面處理 Surface process
旋鈕 Knobs	鋁合金 Aluminum (AL)	電鍍黑色
刻字 Scale	白色 White	Matt black (B)
蓋子 Cap	鋁合金 Aluminum (AL)	
7040		7041
TypeA		TypeB
箭頭 With arrow ◁		刻度比例尺 Scale 1°-3', graduation

(mm)

Order No. 型號 (Type A)	Order No. 型號 (Type B)	A	B	C	D	E	F
7040 - 34 - B6	7041 - 34 - B6	34	B6	M4	27	26	18.3
- 41 - B6	- 41 - B6	41	B6	M5	34	30	26.1
- 50 - B8	- 50 - B8	50	B8	M5	42	34	32
- 60 - B8	- 60 - B8	60	B8	M5	52	38	39.1

Memo

壓花螺絲 Knurled Thumb Screws

8010

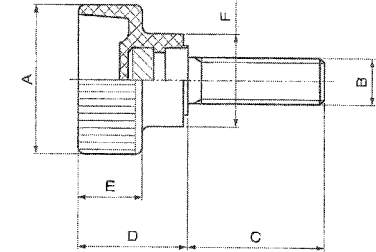
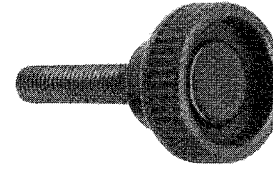

名稱 Name	材質 Material	表面處理 Surface process
旋鈕 Knobs	塑膠 Plastic (KT)	黑色 Black
軸 Spindle	鋼 Steel (ST)	鍍鋅 Zincing (ZI)

(mm)

Order No. 型號 (KT)	A	B	C		D	E	F			
8010 - A - B - C	20	M4	10	15	20	-	-	8.5	8	12
	20	M5	10	15	20	-	-	8.5	8	12
螺紋長度 Thread length	25	M6	10	-	20	30	-	19.5	9	15
外螺紋 External thread	30	M8	-	-	20	30	40	21.5	11	18
旋鈕外徑 Knobs diameter	35	M10	-	-	20	30	40	29	13	21

不銹鋼壓花螺絲 ST. Steel Knurled Thumb Screws

8020

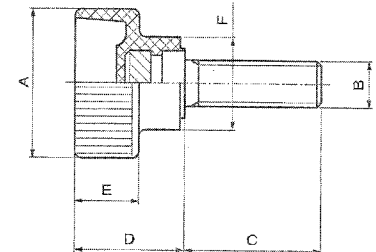
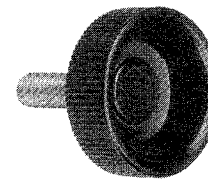

名稱 Name	材質 Material	表面處理 Surface process
旋鈕 Knobs	塑膠 Plastic (KT)	黑色 Black
軸 Spindle	不銹鋼 Stainless steel (SST)	

(mm)

Order No. 型號 (KT)	A	B	C		D	E	F			
8020 - A - B - C	20	M5	10	15	20	-	-	8.5	8	12
螺紋長度 Thread length	25	M6	10	-	20	30	-	19.5	9	15
外螺紋 External thread	30	M8	-	-	20	30	40	21.5	11	18
旋鈕外徑 Knobs diameter										

孔壓花螺帽 enetrated Knurled Nuts

8030

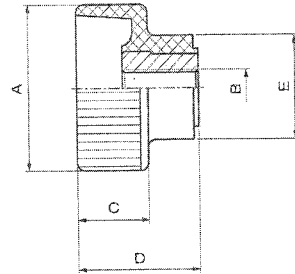
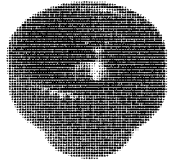

名稱 Name	材質 Material	表面處理 Surfaced process
旋鈕 Knobs	塑膠 Plastic (KT)	黑色 Black
軸 Spindle	鋼 Steel (ST) 銅 Capper (CU)	鍍鋅 Zincing (ZI)

(mm)

Order No. 零件號 (KT)	A	B	C	D	E
8030 - 20 - M 4	20	M4	8	13.5	12
- 20 - M 5	20	M5	8	13.5	12
- 25 - M 6	25	M6	9	19.5	15
- 30 - M 8	30	M8	11	21.5	18
- 35 - M 8	35	M8	13	29	21
- 35 - M10	35	M10	13	29	21

壓花螺帽 Knurled Nuts

8031

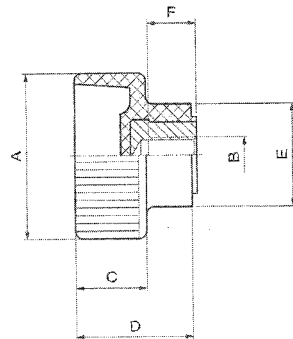
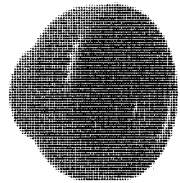

名稱 Name	材質 Material	表面處理 Surfaced process
旋鈕 Knobs	塑膠 Plastic (KT)	黑色 Black
軸 Spindle	鋼 Steel (ST) 銅 Capper (CU)	鍍鋅 Zincing (ZI)

(mm)

Order No. 零件號 (KT)	A	B	C	D	E	F
8031 - 20 - M 4	20	M4	8	13.5	12	7
- 20 - M 5	20	M5	8	13.5	12	8
- 25 - M 6	25	M6	9	19.5	15	12
- 30 - M 8	30	M8	11	21.5	18	12
- 35 - M 8	35	M8	13	29	21	18
- 35 - M10	35	M10	13	29	21	18

[107]

不銹鋼壓花螺帽 ST. Steel Knurled Nuts

8040

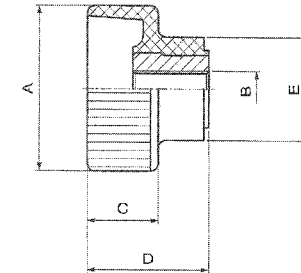
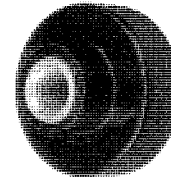

名稱 Name	材質 Material	表面處理 Surfaced process
旋鈕 Knobs	塑膠 Plastic (KT)	黑色 Black
軸 Spindle	不銹鋼 Stainless steel (SST)	

(mm)

Order No. 零件號 (KT)	A	B	C	D	E
8040 - 20 - M 4	20	M4	8	8.5	12
- 20 - M 5	20	M5	8	8.5	12
- 25 - M 6	25	M6	9	19.5	15
- 30 - M 8	30	M8	11	21.5	18
- 35 - M10	35	M10	13	29	21

不銹鋼直頭螺絲 ST. Steel Wing Screws

8050

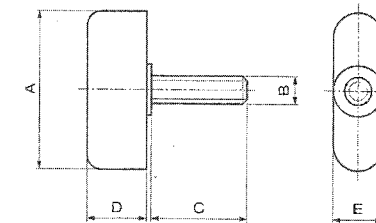
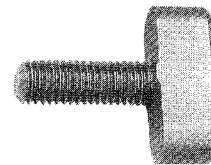

名稱 Name	材質 Material	表面處理 Surfaced process
旋鈕 Knobs	塑膠 Plastic (KT)	黑色 Black
軸 Spindle	鋼 Steel (ST) 銅 Capper (CU)	鍍鋅 Zincing (ZI)

(mm)

Order No. 零件號 (KT)	A	B	C		D	E
8050 - A - B - C -	25	M6	10	20	30	8
螺紋長度 Thread length	30	M8	-	20	30	10
外螺紋 External thread	35	M10	-	30	40	12
手柄長度 Handle length					50	14

[108]

不銹鋼直頭螺帽
ST. Steel Wing Nuts

8060

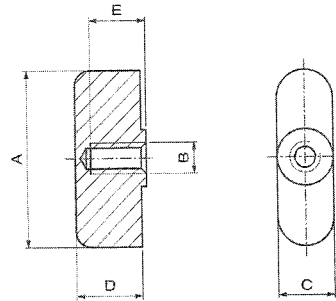
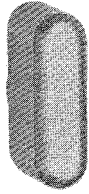

名稱 Name	材質 Material
本體 Base metal	不銹鋼 Stainless steel (SST)

(mm)

Order No. 不銹鋼 (SST)	A	B	C	D	E
8060 - 25 - M 6	25	M6	8	10	7
- 30 - M 8	30	M8	10	12	9
- 35 - M10	35	M10	12	14	11

一字旋鈕螺絲
Wing Knob Screws

8061

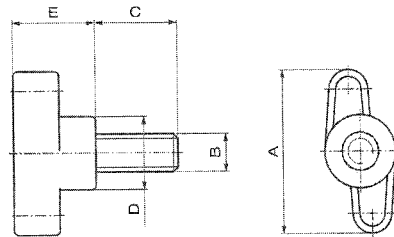
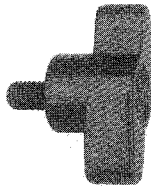

名稱 Name	材質 Material	表面顏色 Surfaced color
旋鈕 Knob	尼龍加玻璃纖維 (KT)	黑色 Black (BK)
軸 Spindle	鋼 Steel (ST)	橘色 Orange (OR)
	鍍鋅 Zincing (ZI)	

(mm)

Order No. 尼龍加玻璃纖維 (KT)	A	B	C				D	E	
8061 - A - B - C - 顏色 (Color)	35	M6	10	15	20	25	30	15.6	18
表面顏色 Surfaced color	35	M8	10	15	20	25	30	15.6	18
螺紋長度 Thread length	45	M8	-	15	20	25	30	35	40
外螺紋 External thread	45	M10	-	15	20	25	30	35	40
手柄長度 Handle length	45	M10	-	15	20	25	30	35	40

[109]

一字旋鈕螺帽
Wing Knob Nuts

8062

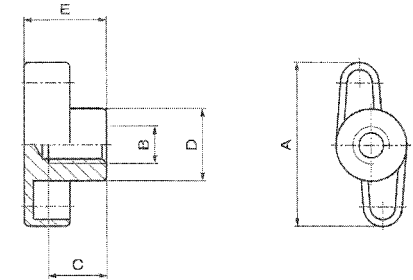
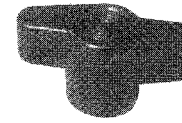

名稱 Name	材質 Material	表面處理 Surfaced process
旋鈕 Knob	尼龍加玻璃纖維 (KT)	黑色 Black (BK)
軸 Spindle	鋼 Steel (ST)	橘色 Orange (OR)
	鍍鋅 Zincing (ZI)	

(mm)

Order No. 尼龍加玻璃纖維 (KT)	A	B	C	D	E
8062 - A - B - 顏色 (Color)	35	M6	14	15.6	18
表面顏色 Surfaced color	35	M8	14	15.6	18
內螺紋 Internal thread	45	M8	18	20	24
手柄長度 Handle length	45	M10	18	20	24

平頭壓花螺絲
Flat Knurled Thumb Screws

8070

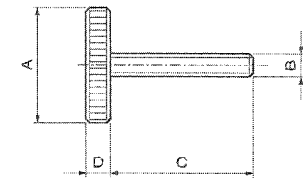
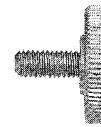

名稱 Name	材質 Material	表面處理 Surfaced process
本體 Base metal	鋼鐵 Steel (ST)	鍍霧銀 Matt silver (EL)

(mm)

Order No. 鋼螺 (ST)	A	B	C	D
8070 - 12 - M 3 - 10	12	M3	10	2.5
- 12 - M 3 - 15	12	M3	15	2.5
- 16 - M 4 - 10	16	M4	10	3.5
- 16 - M 4 - 15	16	M4	15	3.5
- 16 - M 4 - 20	16	M4	20	3.5
- 16 - M 4 - 25	16	M4	25	3.5
- 20 - M 5 - 10	20	M5	10	4
- 20 - M 5 - 15	20	M5	15	4
- 20 - M 5 - 20	20	M5	20	4
- 20 - M 5 - 30	20	M5	30	4
- 24 - M 6 - 15	24	M6	15	5
- 24 - M 6 - 20	24	M6	20	5
- 24 - M 6 - 25	24	M6	25	5
- 24 - M 6 - 30	24	M6	30	5
- 24 - M 6 - 40	24	M6	40	5
- 30 - M 8 - 20	30	M8	20	6
- 30 - M 8 - 25	30	M8	25	6
- 30 - M 8 - 30	30	M8	30	6
- 30 - M 8 - 40	30	M8	40	6
- 36 - M10 - 20	36	M10	20	8
- 36 - M10 - 30	36	M10	30	8
- 36 - M10 - 40	36	M10	40	8

[110]

平頭壓花螺帽 Flat Knurled Nuts

8080

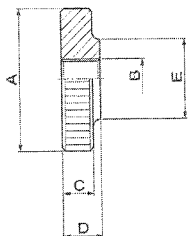

名稱 Name	材質 Material	表面處理 Surfaced process
本體 Base metal	鋼鐵 Steel (ST)	鍍霧銀 Matt silver (EL)

(mm)

Order No. 鋼鐵 (ST)	A	B	C	D	E
8080 - 12 - M3	12	M3	2.5	3	6
- 16 - M4	16	M4	3.5	4	8
- 20 - M5	20	M5	4	5	10
- 24 - M6	24	M6	5	6	12
- 30 - M8	30	M8	6	8	16
- 36 - M10	36	M10	8	10	20
- 40 - M12	40	M12	10	12	22

凸型壓花螺絲 Knurled Thumb Screws

8090

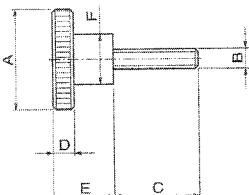
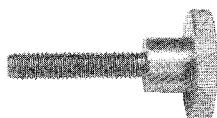

名稱 Name	材質 Material	表面處理 Surfaced process
本體 Base metal	鋼鐵 Steel (ST)	鍍霧銀 Matt silver (EL)

(mm)

Order No. 鋼鐵 (ST)	A	B	C	D	E	F
8090 - 12 - M3 - 10	12	M3	10	2.5	7.5	6
- 12 - M3 - 15	12	M3	15	2.5	7.5	8
- 16 - M4 - 10	16	M4	10	3.5	9.5	8
- 16 - M4 - 15	16	M4	15	3.5	9.5	8
- 16 - M4 - 20	16	M4	20	3.5	9.5	8
- 16 - M4 - 25	16	M4	25	3.5	9.5	8
- 20 - M5 - 10	20	M5	10	4	11.5	10
- 20 - M5 - 15	20	M5	15	4	11.5	10
- 20 - M5 - 20	20	M5	20	4	11.5	10
- 20 - M5 - 25	20	M5	25	4	11.5	10
- 20 - M5 - 30	20	M5	30	4	11.5	10
- 24 - M6 - 15	24	M6	15	5	15	12
- 24 - M6 - 20	24	M6	20	5	15	12
- 24 - M6 - 25	24	M6	25	5	15	12
- 24 - M6 - 30	24	M6	30	5	15	12
- 24 - M6 - 35	24	M6	35	5	15	12
- 30 - M8 - 20	30	M8	20	6	18	16
- 30 - M8 - 30	30	M8	30	6	18	16
- 30 - M8 - 40	30	M8	40	6	18	16
- 36 - M10 - 20	36	M10	20	8	20	20
- 36 - M10 - 30	36	M10	30	8	20	20
- 36 - M10 - 40	36	M10	40	8	20	20

[111]

不銹鋼凸型壓花螺帽 ST. Steel Knurled Thumb Screws

8100

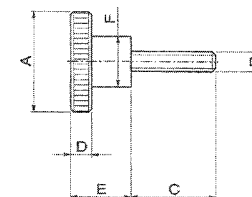
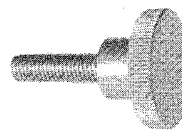

名稱 Name	材質 Material
本體 Base metal	不銹鋼 Stainless steel (SST)

(mm)

Order No. 不銹鋼 (SST)	A	B	C	D	E	F
8100 - 16 - M4 - 5	16	M4	5	3.5	9.5	8
- 16 - M4 - 10	16	M4	10	3.5	9.5	8
- 16 - M4 - 15	16	M4	15	3.5	9.5	8
- 20 - M5 - 10	20	M5	10	4	11.5	10
- 20 - M5 - 15	20	M5	15	4	11.5	10
- 20 - M5 - 20	20	M5	20	4	11.5	10
- 24 - M6 - 10	24	M6	10	5	15	12
- 24 - M6 - 15	24	M6	15	5	15	12
- 24 - M6 - 20	24	M6	20	5	15	12
- 24 - M6 - 25	24	M6	25	5	15	12
- 30 - M8 - 20	30	M8	20	6	18	16
- 30 - M8 - 30	30	M8	30	6	18	16
- 30 - M8 - 40	30	M8	40	6	18	16

壓花螺帽 Knurled Nuts

8110

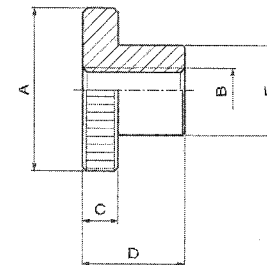
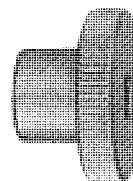

名稱 Name	材質 Material	表面處理 Surfaced process
本體 Base metal	鋼鐵 Steel (ST)	鍍霧銀 Matt silver (EL)

(mm)

Order No. 鋼鐵 (ST)	A	B	C	D	E
8110 - 12 - M3	12	M3	2.5	7.5	6
- 16 - M4	16	M4	3.5	9.5	8
- 20 - M5	20	M5	4	11.5	10
- 24 - M6	24	M6	5	15	12
- 30 - M8	30	M8	6	18	16
- 36 - M10	36	M10	8	23	20
- 40 - M12	40	M12	10	25	22

[112]

不銹鋼壓花螺帽
ST. Steel Knurled Nuts

8120

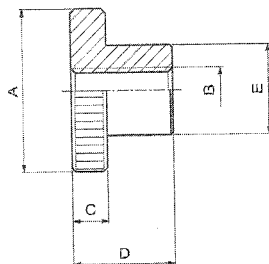
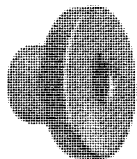

名稱	材質
Name	Material
本體 Base metal	不銹鋼 Stainless steel (SST)

(mm)

Order No. (ST)	A	B	C	D	E
8120 - 16 - M4	16	M4	3.5	11.5	8
- 20 - M5	20	M5	4	13	10
- 24 - M6	24	M6	5	15	12
- 30 - M8	30	M8	6	18	16

壓花螺帽
Knurled Nuts

8130

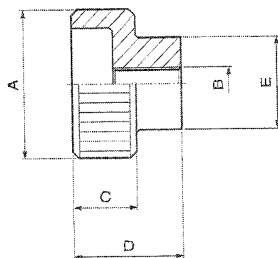
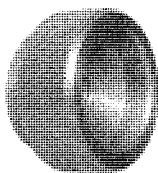

名稱	材質	表面處理
Name	Material	Surfaced process
本體 Base metal	鋼鐵 Steel (ST)	霧銀 Matt silver (EL)

(mm)

Order No. (ST)	A	B	C	D	E
8130 - 16 - M4	16	M4	6	10	8
- 20 - M5	20	M5	8	12	14
- 24 - M6	24	M6	10	14	16
- 30 - M8	30	M8	12	17	20
- 36 - M10	36	M10	14	20	28
- 40 - M12	40	M12	16	24	32

不銹鋼壓花螺帽
ST. Steel Knurled Nuts

8140

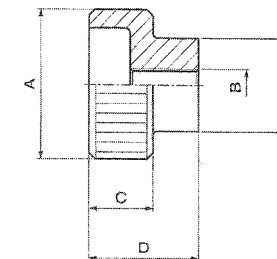
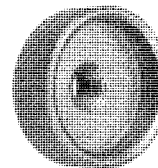

名稱	材質
Name	Material
本體 Base metal	不銹鋼 Stainless steel (SST)

(mm)

Order No. (SST)	A	B	C	D	E
8140 - 16 - M4	16	M4	6	10	8
- 20 - M5	20	M5	8	12	14
- 24 - M6	24	M6	10	14	16
- 30 - M8	30	M8	12	17	20
- 36 - M10	36	M10	14	20	28
- 40 - M12	40	M12	16	24	32

Memo

定位柱 Indexing Plungers

9010

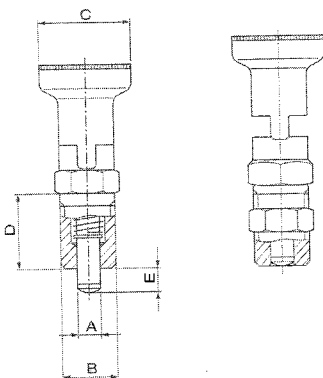
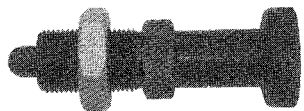

名稱 Name	材質 Material	表面處理 Surface process
本體 Base metal	鋼鐵 Steel (ST)	染黑 Dyed black (B)
拉柄 Knob	塑膠 Plastic (KT)	黑色 Black

(mm)

Order No. 鋼鐵 (ST)	A	B	C	D	E
9010 - 5	5	M10 x 1	21	17	5
- 6	6	M12 x 1.5	25	20	6
- 8	8	M16 x 1.5	31	26	8
- 10	10	M20 x 1.5	31	33	10

定位柱 Cam Action Indexing Plungers

9020

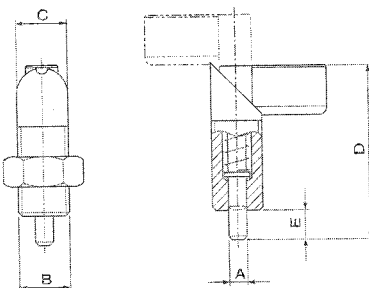
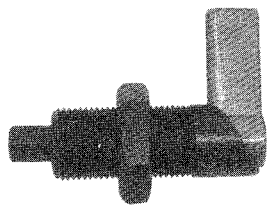

名稱 Name	材質 Material	表面處理 Surface process
本體 Base metal	鋼鐵 Steel (ST)	染黑
拉柄 Knob	不銹鋼 Stainless steel (SST)	染黑 (B)
螺帽 Nut	鋼鐵 Steel (ST)	染黑
	不銹鋼 Stainless steel (SST)	染黑 (B)

(mm)

Order No. 鋼鐵 (ST)	Order No. 不銹鋼 (SST)	A	B	C	D	E
9020 - 8	9021 - 8	8	M20 x 1.5	20	69	12
- 10	- 10	10	M20 x 1.5	20	69	12
- 12	- 12	12	M20 x 1.5	20	69	12

不銹鋼定位珠 ST. Steel Spring Plungers

9030

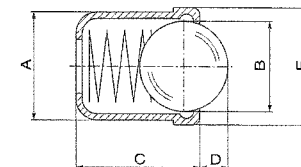

名稱 Name	材質 Material
本體 Base metal	不銹鋼 Stainless steel (SST)

(mm)

Order No. 不銹鋼 (SST)	A	B	C	D	E
9030 - 3	3	3	5	0.8	1.5
- 4	4	3	5	0.8	1.5
- 5	5	4	6	1	1.8
- 6	6	5	7	1.6	1.1
- 8	8	6.5	9	1.9	2.3
- 10	10	8.5	13.5	3.1	6.5
- 12	12	10	16	3.8	10.6

定位珠 Spring Plungers

9040

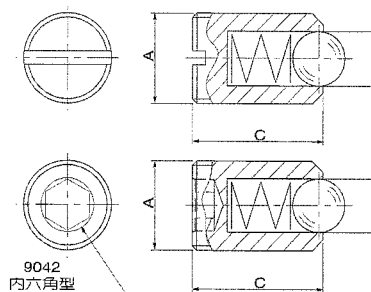

名稱 Name	材質 Material
本體 Base metal	鋼鐵 Steel (ST)
	不銹鋼 Stainless steel (SST)

(mm)

Order No. 鋼鐵 (ST)	Order No. 不銹鋼 (SST)	Order No. 鋼鐵 (ST)	A	B	C
9040 - M 3	9041 - M 3		M3	1.5	7
- M 4	- M 4	9042 - M 4	M4	2.5	9
- M 5	- M 5	- M 5	M5	3	12
- M 6	- M 6	- M 6	M6	3.5	14
- M 8	- M 8	- M 8	M8	4.5	16
- M10	- M10	- M10	M10	6	19
- M12	- M12	- M12	M12	8	22
- M16	- M16	- M16	M16	10	24
- M20	- M20	- M20	M20	12	30
- M24	- M24	- M24	M24	15	34

9042
內六角型
(Internal hexagon)

可動聯結螺絲 Grub Screws

9050

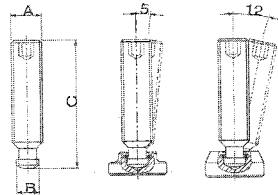

名稱 Name	材質 Material	表面處理 Surface process
本體 Base metal	鋼鐵 Steel (ST)	染黑 Dyed black (B)

(mm)

Order No. 鋼鐵 (ST)	A	B	C
9050 - M6 - 30	M6	4.5	30
- M6 - 35	M6	4.5	35
- M6 - 40	M6	4.5	40
- M8 - 35	M8	6	35
- M8 - 40	M8	6	40
- M8 - 45	M8	6	45
- M10 - 45	M10	8	45
- M10 - 50	M10	8	50
- M10 - 55	M10	8	55
- M12 - 50	M12	8	50
- M12 - 60	M12	8	60
- M12 - 65	M12	8	65
- M16 - 65	M16	12	65
- M16 - 70	M16	12	70
- M16 - 75	M16	12	75
- M20 - 80	M20	15.5	80
- M20 - 90	M20	15.5	90
- M20 - 100	M20	15.5	100

等高螺絲 Contour Screws

9055

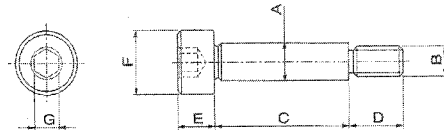
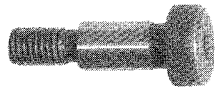

名稱 Name	材質 Material	表面處理 Surface process
本體 Base metal	鋼鐵 Steel (ST)	染黑 Dyed black (B)

(mm)

Order No. 鋼鐵 (ST)	A	B	C								D	E	F	G	
9055 - A - B - C - 顏色 (Color)	6	M5	20	25	30	35	40	45	50	55	60	10	4.5	10	3
			65	70	75	80	85	90	100						
	8	M6	20	25	30	35	40	45	50	55	60	11	5.5	13	4
			65	70	75	80	85	90	100						
	10	M8	20	25	30	35	40	45	50	55	60	13	7	16	5
			65	70	75	80	85	90	100	110	120				
	12	M10	20	25	30	35	40	45	50	55	60	16	9	18	6
			65	70	75	80	85	90	100	110	120				
	13	M10	20	25	30	35	40	45	50	55	60	16	9	18	6
			65	70	75	80	85	90	100						
	16	M12	20	25	30	35	40	45	50	55	60	18	10	24	8
			65	70	75	80	85	90	100	110	120				
	20	M16	30	35	40	45	50	55	60	65	70	22	14	30	10
			75	80	85	90	100	110	120	130	140				
	24	M20	50	60	70	80	90	100	110		27	16	36	12	

[117]

支撐座 Thrust Pads

9060

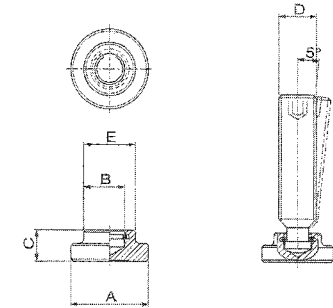

名稱 Name	材質 Material	表面處理 Surface process
本體 Base metal	鋼鐵 Steel (ST)	染黑 Dyed black (B)

(mm)

Order No. 鋼鐵 (ST)	A	B	C	D	E
9060 - 12 - 4.6	12	4.6	7	M6	10
- 16 - 6.1	16	6.1	9	M8	12
- 20 - 8.1	20	8.1	11	M10	15
- 25 - 8.1	25	8.1	13	M12	18
- 32 - 12.1	32	12.1	15	M16	22
- 40 - 15.6	40	15.6	16	M20	28

搖擺螺絲 Swing Bolts

9070

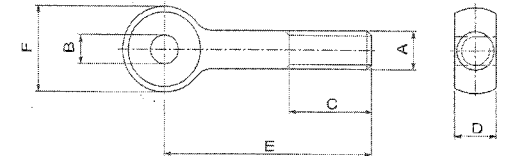
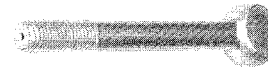

名稱 Name	材質 Material	表面處理 Surface process
本體 Base metal	鋼鐵 Steel (ST)	鍍霧銀 Matt silver (EL)

(mm)

Order No. 鋼鐵 (ST)	A	B	C	D	E	F
9070 - M6 - 50	M6	B6	32	7	50	14
- M6 - 75	M6	B6	32	7	75	14
- M8 - 50	M8	B8	32	9	50	18
- M8 - 75	M8	B8	32	9	75	18
- M10 - 55	M10	B10	40	12	55	20
- M10 - 75	M10	B10	40	12	75	20
- M10 - 100	M10	B10	40	12	100	20
- M12 - 75	M12	B12	40	14	75	25
- M12 - 100	M12	B12	40	14	100	25
- M12 - 130	M12	B12	40	14	130	25
- M16 - 75	M16	B16	50	17	75	32
- M16 - 100	M16	B16	50	17	100	32
- M16 - 130	M16	B16	50	17	130	32
- M20 - 100	M20	B18	63	22	100	40
- M20 - 130	M20	B18	63	22	130	40
- M20 - 160	M20	B18	63	22	160	40

[118]

不銹鋼搖擺螺絲 ST. Steel Swing Bolts

9071

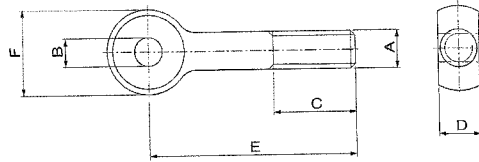

名稱 Name	材質 Material
本體 Base metal	不銹鋼 Stainless steel (SST)

(mm)

Order No. 不銹鋼 (SST)	A	B	C	D	E	F
9071 - M 6 - 50	M6	B6	32	7	50	14
- M 6 - 75	M6	B6	32	7	75	14
- M 8 - 50	M8	B8	32	9	50	18
- M 8 - 75	M8	B8	32	9	75	18
- M10 - 55	M10	B10	40	12	55	20
- M10 - 75	M10	B10	40	12	75	20
- M10 - 100	M10	B10	40	12	100	20
- M12 - 75	M12	B12	40	14	75	25
- M12 - 100	M12	B12	40	14	100	25
- M12 - 130	M12	B12	40	14	130	25
- M16 - 75	M16	B16	50	17	75	32
- M16 - 100	M16	B16	50	17	100	32
- M16 - 130	M16	B16	50	17	130	32

T型螺帽 T-Nuts

9080

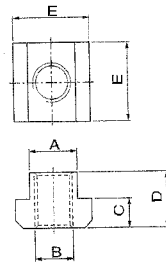
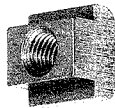

名稱 Name	材質 Material	表面處理 Surfaced process
本體 Base metal	鋼鐵 Steel (ST)	電鍍黑色 Matt black (B) 電鍍霧銀 Matt silver (EL)

(mm)

Order No. 鋼鐵 (ST)	A ^{-0.3 -0.5}	B	C ^{-0.5}	D	E ^{-0.5}
9080 - 5 - M 4	5	M4	3	6.5	9
- 6 - M 5	8	M5	4	8	10
- 8 - M 6	8	M6	6	10	13
- 10 - M 6	10	M6	6	12	15
- 10 - M 8	10	M8	6	12	15
- 12 - M10	12	M10	7	14	18
- 14 - M12	14	M12	8	16	22
- 16 - M12	16	M12	9	18	25
- 16 - M14	16	M14	9	18	25
- 18 - M16	18	M16	10	20	28
- 20 - M16	20	M16	12	24	32
- 20 - M18	20	M18	12	24	32
- 22 - M20	22	M20	14	28	35
- 24 - M22	24	M22	16	32	40
- 28 - M24	28	M24	18	36	44

[119]

凸緣螺帽 Collar Nuts

9081

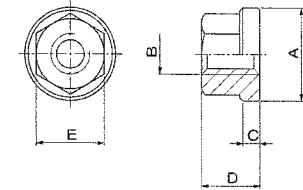
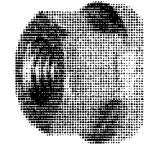

名稱 Name	材質 Material	表面處理 Surfaced process
本體 Base metal	鋼鐵 Steel (ST)	電鍍黑色 Matt black (B)

(mm)

Order No. 鋼鐵 (ST)	A	B	C	D	E
9081 - 14 - M 6	14	M6	3	9	10
- 18 - M 8	18	M8	3.5	12	13
- 22 - M10	22	M10	4	15	16
- 25 - M12	25	M12	4	18	18
- 28 - M14	28	M14	4	21	22
- 31 - M16	31	M16	5	24	24
- 37 - M20	37	M20	6	30	30
- 45 - M24	45	M24	6	36	36
- 58 - M30	58	M30	8	45	46
- 68 - M36	68	M36	10	54	55

沉頭孔墊片 Countersunk Washers

9090

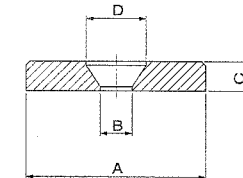

名稱 Name	材質 Material	表面處理 Surfaced process
本體 Base metal	鋼鐵 Steel (ST)	電鍍黑色 Matt black (B)

(mm)

Order No. 鋼鐵 (ST)	A	B	C	D
9090 - 16 - 4.3	16	4.3	3	8
- 20 - 4.3	20	4.3	3	8
- 22 - 5.3	22	5.3	3.5	10
- 25 - 5.3	25	5.3	3.5	10
- 28 - 5.3	28	5.3	3.5	10
- 32 - 6.4	32	6.4	4	12
- 36 - 6.4	36	6.4	4	12
- 40 - 6.4	40	6.4	5	12
- 45 - 6.4	45	6.4	6	12
- 52 - 6.4	52	6.4	6	12

[120]

公件球型華司 Male Spherical Washers

9095

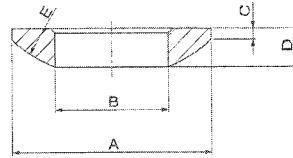

名稱 Name	材質 Material	表面處理 Surfaced process
本體 Base metal	鋼鐵 Steel (ST)	電鍍黑色 Matt black (B)

(mm)

Order No. 鋼鐵 (ST)	A	B	C	D	E
9095 - 12 - 6.4	12	6.4	0.7	2.3	R9
- 17 - 8.4	17	8.4	0.6	3.2	R12
- 21 - 10.5	21	10.5	0.8	4	R15
- 24 - 13	24	13	1.1	4.6	R17
- 28 - 15	28	15	1.2	5	R22
- 30 - 17	30	17	1.3	5.3	R22
- 36 - 21	36	21	2	6.3	R27
- 44 - 25	44	25	2.4	8.2	R32
- 56 - 31	56	31	3.6	11.2	R41
- 63 - 37	68	37	4.6	14	R50
- 78 - 43	78	43	6.5	17	R58
- 92 - 50	92	50	8	21	R67

母件圓錐型座 Female Spherical Washers

9096

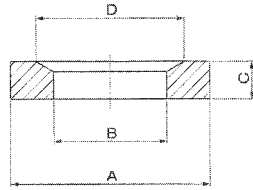

名稱 Name	材質 Material	表面處理 Surfaced process
本體 Base metal	鋼鐵 Steel (ST)	電鍍黑色 Matt black (B)

(mm)

Order No. 鋼鐵 (ST)	A	B	C	D
9096 - 12 - 7.1	12	7.1	2.8	11
- 17 - 9.6	17	9.6	3.5	14.5
- 21 - 12	21	12	4.2	18.5
- 24 - 14.2	24	14.2	5	20
- 28 - 16.5	28	16.5	5.6	24.8
- 30 - 19	30	19	6.2	26
- 36 - 23.2	36	23.2	7.5	31
- 44 - 28	44	28	9.5	37
- 56 - 35	56	35	12	49
- 68 - 42	68	42	15	60
- 78 - 49	78	49	18	70
- 92 - 56	92	56	22	82

[121]

吊環 Lifting Eye Bolts

9100

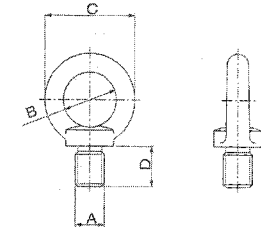
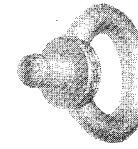

名稱 Name	材質 Material	表面處理 Surfaced process
本體 Base metal	鋼鐵 Steel (ST)	電五彩 Mulyivolotrf-plstnh

(mm)

Order No. 鋼鐵 (ST)	A	B	C	D	Loading 荷重 (kg)
9100 - M 6	M6	20	33	15	80
- M 8	M8	20	33	15	80
- M10	M10	25	41	18	150
- M12	M12	30	50	22	220
- M14	M14	35	60	27	300
- M16	M16	35	60	27	450
- M18	M18	40	72	30	630
- M20	M20	40	72	30	630
- M22	M22	50	90	35	950
- M24	M24	50	90	35	950
- M27	M27	60	110	45	1500
- M30	M30	60	110	45	1500
- M33	M33	70	133	55	2300
- M36	M36	70	133	55	2300
- M42	M42	80	151	65	3400
- M48	M48	80	151	65	4500
- M64	M64	110	210	90	9000

不銹鋼吊環 ST. Steel Lifting Eye Bolts

9101

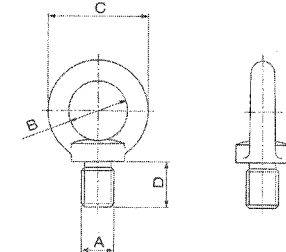
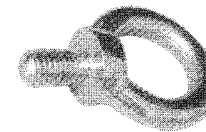

名稱 Name	材質 Material
本體 Base metal	不銹鋼 Stainless steel (SST)

(mm)

Order No. 不銹鋼 (SST)	A	B	C	D	Loading 荷重 (kg)
9101 - M 6	M6	20	33	15	80
- M 8	M8	20	33	15	80
- M10	M10	25	41	18	150
- M12	M12	30	50	22	220
- M14	M14	35	60	27	300
- M16	M16	35	60	27	450
- M18	M18	40	72	30	630
- M20	M20	40	72	30	630
- M22	M22	50	90	35	950
- M24	M24	50	90	35	950

[122]

吊環 Lifting Eye Bolts

9110

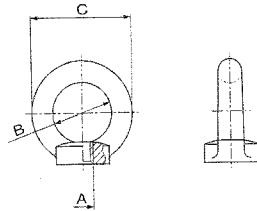

名稱 Name	材質 Material	表面處理 Surface process
本體 Base metal	鋼鐵 Steel (ST)	電五彩 Mulyivolotrf-plstinh

(mm)

Order No. 鋼鐵 (ST)	A	B	C	Loading 荷重 (kg)
9110 - M 6	M6	20	32	80
- M 8	M8	20	32	80
- M10	M10	25	38	150
- M12	M12	30	50	220
- M14	M14	35	70	300
- M16	M16	35	70	450
- M20	M20	40	72	630
- M22	M22	50	90	950
- M24	M24	50	90	950
- M27	M27	50	90	1500
- M30	M30	60	110	1500
- M36	M36	70	133	2300

不銹鋼吊環 ST. Steel Lifting Eye Bolts

9111

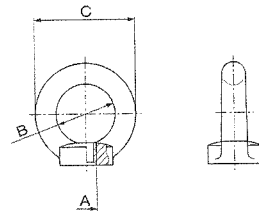
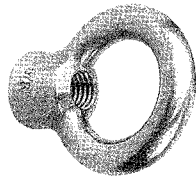

名稱 Name	材質 Material
本體 Base metal	不銹鋼 Stainless steel (SST)

(mm)

Order No. 不銹鋼 (SST)	A	B	C	Loading 荷重 (kg)
9111 - M 6	M6	20	33	80
- M 8	M8	20	33	80
- M10	M10	25	41	150
- M12	M12	30	50	220
- M14	M14	35	60	300
- M16	M16	35	60	450
- M18	M18	40	72	630
- M20	M20	40	72	950
- M22	M22	50	90	950
- M24	M24	50	90	950

[123]

吊模栓 Hook Screws

9115

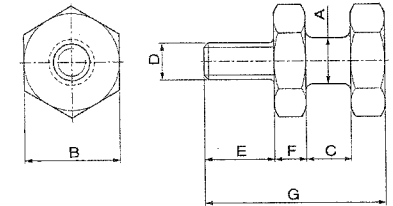
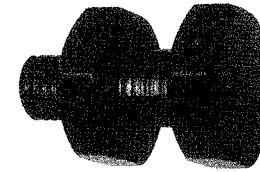

名稱 Name	材質 Material	表面處理 Surface process
本體 Base metal	鋼鐵 Steel (ST)	電鍍黑色 Matt balck (B)

(mm)

Order No. 鋼鐵 (ST)	A	B	C	D	E	F	G
9115 - 13 - M10	13	26	10	M10	20	8	46
- 16 - M12	16	32	13	M12	24	10	57
- 20 - M16	20	35	18	M16	30	13	75
- 25 - M20	25	42	20	M20	37	16	90
- 32 - M24	32	50	25	M24	47	20	111

機械吊鉤 Machinery Hooks

9116

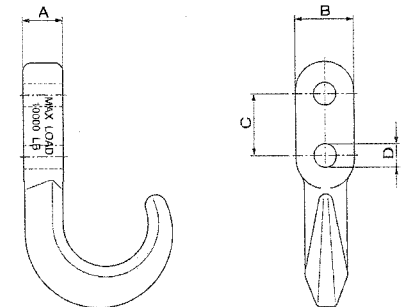
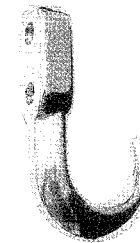

名稱 Name	材質 Material	表面處理 Surface process
本體 Base metal	不銹鋼 Stainless steel (SST)	鍍亮鉻 Chrome bright (CR)

(mm)

Order No. 不銹鋼 (SST)	A	B	C	D	Loading 荷重 (kg)
9116	23	34	35	13	4500 (10000 LB)

[124]

平絞鏈 Knuckle Joints

9120

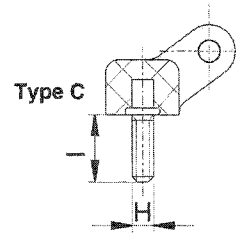
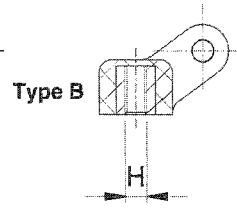
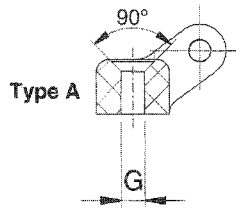
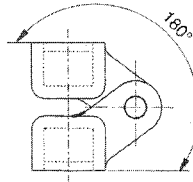
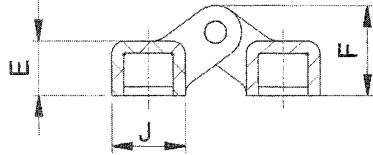
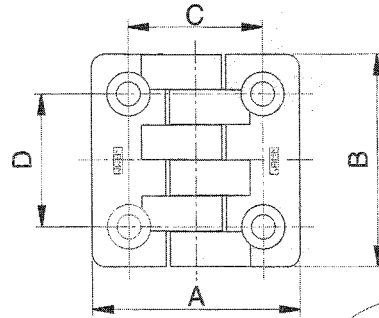
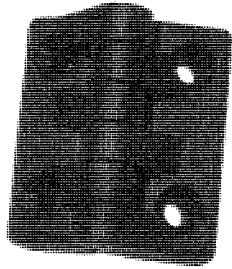

名稱 Name	材質 Material	表面處理 Surfaced process
本體 Base metal	尼龍加玻璃纖維 (KT)	全黑色 Black (BK)
梢子 Pin	不銹鋼 Stainless steel (SST)	

(mm)

	Order No. 尼龍加玻璃纖維 (KT)	A	B	C	D	E	F	G	H	I	J
Type A	9120 - 40 - 40	40	40	25.5	25.5	10	16.5	4.2	-	-	14
	- 48 - 48	48	48	31	30	12.5	20.5	5.5	-	-	17
	- 65 - 65	65	65	40	40	14	25	6.5	-	-	24
	- 98 - 98	98	98	63	60	21	37	10.5	-	-	35
Type B	- 48 - 48	48	48	31	30	12.5	20.5	-	M5	M6	17
	- 65 - 65	65	65	40	40	14	25	-	M6	-	24
	- 98 - 98	98	98	63	60	21	37	-	M10	-	35
	- 48 - 48	48	48	31	30	12.5	20.5	-	M5	-	15
Type C	- 65 - 65	65	65	40	40	14	25	-	M6	-	20
	- 98 - 98	98	98	63	60	21	37	-	M10	-	20
	- 98 - 98	98	98	63	60	21	37	-	M10	-	35

標準型水平調整座 Standard Type Adjustable Seats

9130

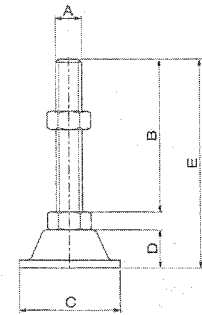

名稱 Name	材質 Material	表面處理 Surfaced process
腳座 Seat	鋼鐵 Steel (ST) 不銹鋼 Stainless steel (SST)	電五彩
螺牙 Screw	鋼鐵 Steel (ST) 不銹鋼 Stainless steel (SST)	Mulyivolotrf-pistinh

(mm)

Order No. 鋼鐵 (ST)	Order No. 不銹鋼 (SST)	A	B	C	D	E	Loading 荷重 (kg)
9130 - M8 - 40	9131 - M8 - 40	M8	40	48	11.5	58	100
- M8 - 50	- M8 - 50	M8	50	48	11.5	68	100
- M8 - 75	- M8 - 75	M8	75	48	11.5	93	100
- M12 - 75	- M12 - 75	M12	75	65	14	99	200
- M12 - 100	- M12 - 100	M12	100	65	14	124	200
- M12 - 150	- M12 - 150	M12	150	65	14	174	200
- M16 - 75	- M16 - 75	M16	75	75	19	107	300
- M16 - 100	- M16 - 100	M16	100	75	19	132	300
- M16 - 150	- M16 - 150	M16	150	75	19	182	300

防震型水平調整座 Shockproof Type Adjustable Seats

9140

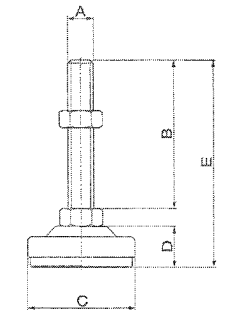
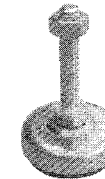

名稱 Name	材質 Material	表面處理 Surfaced process
腳座 Seat	鋼鐵 Steel (ST) 不銹鋼 Stainless steel (SST)	電五彩
螺牙 Screw	鋼鐵 Steel (ST) 不銹鋼 Stainless steel (SST)	Mulyivolotrf-pistinh
防滑墊 Skidproof	橡膠 Rubber	

(mm)

Order No. 鋼鐵 (ST)	Order No. 不銹鋼 (SST)	A	B	C	D	E	Loading 荷重 (kg)
9140 - M8 - 40	9141 - M8 - 40	M8	40	40	13.5	60	100
- M8 - 50	- M8 - 50	M8	50	40	13.5	70	100
- M8 - 75	- M8 - 75	M8	75	40	13.5	95	100
- M12 - 75	- M12 - 75	M12	75	50	20	105	200
- M12 - 100	- M12 - 100	M12	100	50	20	130	200
- M12 - 150	- M12 - 150	M12	150	50	20	180	200
- M16 - 75	- M16 - 75	M16	75	60	22	110	300
- M16 - 100	- M16 - 100	M16	100	60	22	135	300
- M16 - 150	- M16 - 150	M16	150	60	22	185	300

防震腳座 Aseismatic Seats

9150

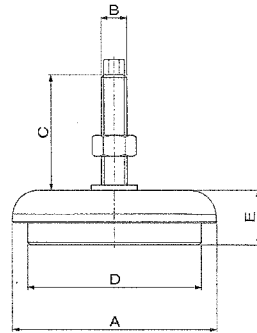
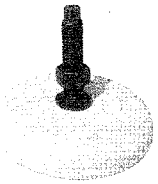

名稱 Name	材質 Material	表面處理 Surfaced process
腳座 Seat	鋼鐵 Steel (ST)	黃色烤漆
螺牙 Screw	鋼鐵 Steel (ST)	Paint yellow (YE)
防滑墊 Skidproof	橡膠 Rubber	

Order No. 鋼鐵 (ST)	A	B	C	D	E	Loading 荷重 (kg)
9150 - 90 - M12 - 100	90	M12	100	50	32	500
- 120 - M12 - 100	120	M12	100	95	38	600
- 120 - M16 - 110	120	M16	110	95	38	800
- 160 - M16 - 110	160	M16	110	135	41	1000
- 160 - M20 - 120	160	M20	120	135	41	1200
- 200 - M12 - 100	200	M12	120	175	47	2500
- 200 - M24 - 180	200	M24	180	175	47	2800
- 250 - M30 - 180	250	M30	180	225	57	4500

防震腳座 Aseismatic Seats

9170

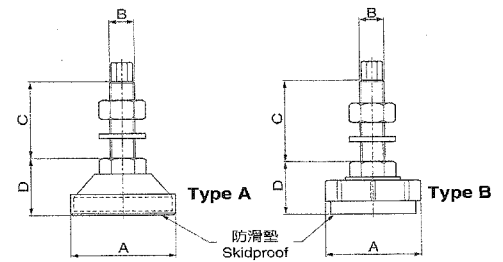

名稱 Name	材質 Material	表面處理 Surfaced process
腳座 Seat	鋼鐵 Steel (ST)	電鍍黑色
螺牙 Screw	鋼鐵 Steel (ST)	Matt black (B)
防滑墊 Skidproof	橡膠 Rubber	

Order No. 鋼鐵 (ST)	A	B	C	D	Loading 荷重 (kg)
9170 - 100 - M16 - 75	100	M16	75	48	800
- 100 - M16 - 110	100	M16	110	48	800
- 100 - M16 - 150	100	M16	150	48	800
- 100 - M16 - 200	100	M16	200	48	800
- 100 - M16 - 240	100	M16	240	48	800
9171 - 100 - M20 - 75	100	M20	75	55	1000
- 100 - M20 - 110	100	M20	110	55	1000
- 100 - M20 - 150	100	M20	150	55	1000
- 100 - M20 - 200	100	M20	200	55	1000
- 100 - M20 - 240	100	M20	240	55	1000
- 150 - M20 - 75	150	M20	75	58	1500
- 150 - M20 - 110	150	M20	110	58	1500
- 150 - M20 - 150	150	M20	150	58	1500
- 150 - M20 - 200	150	M20	200	58	1500
- 150 - M20 - 240	150	M20	240	58	1500

精密型腳座 Detailed Seats

9160

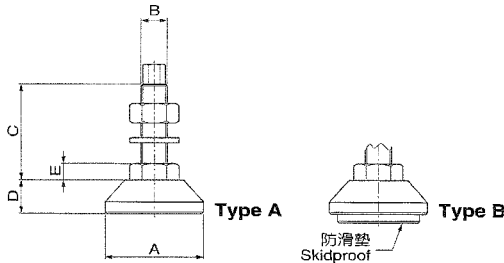

名稱 Name	材質 Material	表面處理 Surfaced process
腳座 Seat	鋼鐵 Steel (ST)	電鍍黑色
螺牙 Screw	鋼鐵 Steel (ST)	Matt black (B)
防滑墊 Skidproof	橡膠 Rubber	

Order No. Type A	Order No. Type B	A	B	C	D	E	Loading 荷重 (kg)
9160 - 60 - M16 - 75	9161 - 60 - M16 - 75	60	M16	75	21	10	500
- 60 - M16 - 110	- 60 - M16 - 110	60	M16	110	21	10	500
- 60 - M16 - 150	- 60 - M16 - 150	60	M16	150	21	10	500
- 60 - M16 - 200	- 60 - M16 - 200	60	M16	200	21	10	500
- 70 - M16 - 75	- 70 - M16 - 75	70	M16	75	21	10	800
- 70 - M16 - 110	- 70 - M16 - 110	70	M16	110	21	10	800
- 70 - M16 - 150	- 70 - M16 - 150	70	M16	150	21	10	800
- 70 - M16 - 200	- 70 - M16 - 200	70	M16	200	21	10	800
- 80 - M20 - 75	- 80 - M20 - 75	80	M20	75	21	10	1000
- 80 - M20 - 110	- 80 - M20 - 110	80	M20	110	21	10	1000
- 80 - M20 - 150	- 80 - M20 - 150	80	M20	150	21	10	1000
- 80 - M20 - 200	- 80 - M20 - 200	80	M20	200	21	10	1000

[127]

多功能防震腳座 Multi-Function Detailed Seats

9180

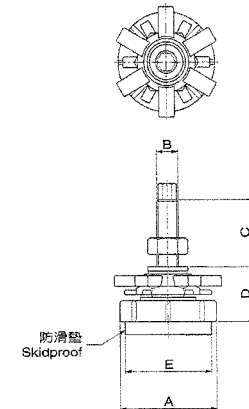

名稱 Name	材質 Material	表面處理 Surfaced process
腳座 Seat	鋼鐵 Steel (ST)	染黑色
螺牙 Screw	鋼鐵 Steel (ST)	Dyed black (B)
防滑墊 Skidproof	橡膠 Rubber	

Order No. 鋼鐵 (ST)	A	B	C	D	E	Loading 荷重 (kg)	Limit load 荷重極限 (kg)
9180 - 100 - M12 - 50	100	M12	50	77	90	600	7900
- 150 - M16 - 110	150	M16	110	100	135	1000	7900
- 200 - M20 - 120	200	M20	120	105	180	2500	7900
- 250 - M24 - 180	250	M24	180	105	230	4000	7900

[128]

機械尺 Machine Rulers

0010

名稱 Name	材質 Material
本體 Base metal	不銹鋼 Stainless steel (SST)
刻度 Scale / 公制 Metric	
0010 - UL Type A	
刻度在上方，零在中邊 Upper Scale and the zero of the scale from left side	
0010 - UR Type B	
刻度在上方，零在右邊 Upper Scale and the zero of the scale from right side	
0010 - DL Type C	
刻度在下方，零在中邊 Nether Scale and the zero of the scale from left side	
0010 - DR Type D	
刻度在下方，零在右邊 Nether Scale and the zero of the scale from right side	
0010 - UC Type E	
刻度在上方，零在中邊 Upper Scale and the zero of the scale from middle	
0010 - DC Type F	
刻度在下方，零在中邊 Nether Scale and the zero of the scale from middle	

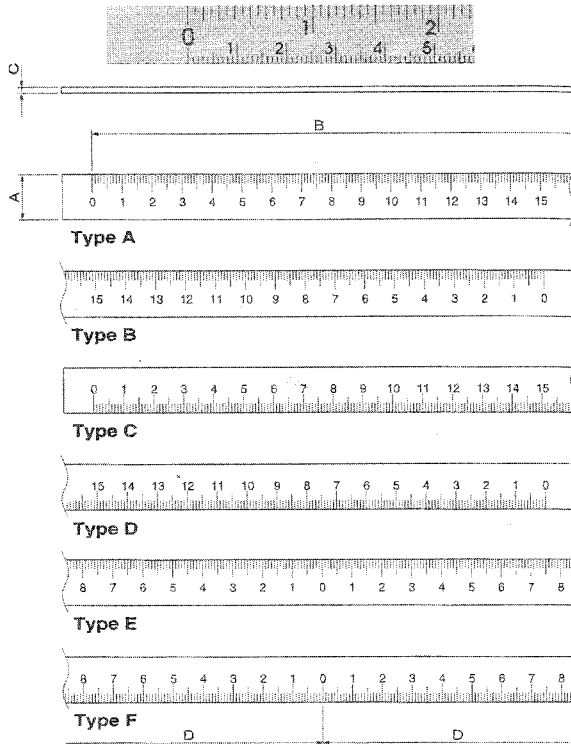

(mm)

Order No. Type A	Order No. Type B	A	B	C	D
0010 - U 150 L	0010 - U 150 R	16	150	0.8	75
- U 300 L	- U 300 R	25	300	1.0	150
- U 600 L	- U 600 R	30	600	1.2	300
- U 1000L	- U 1000R	35	1000	1.5	500
- U 1500L	- U 1500R	40	1500	1.5	750
- U 2000L	- U 2000R	40	2000	1.5	1000

Order No. Type C	Order No. Type D	A	B	C	D
0010 - D 150 L	0010 - D 150 R	16	150	0.8	75
- D 300 L	- D 300 R	25	300	1.0	150
- D 600 L	- D 600 R	30	600	1.2	300
- D 1000L	- D 1000R	35	1000	1.5	500
- D 1500L	- D 1500R	40	1500	1.5	750
- D 2000L	- D 2000R	40	2000	1.5	1000

Order No. Type E	Order No. Type F	A	B	C	D
0010 - U 150 C	0010 - D 150 C	16	150	0.8	75
- U 300 C	- D 300 C	25	300	1.0	150
- U 600 C	- D 600 C	30	600	1.2	300
- U 1000C	- D 1000C	35	1000	1.5	500
- U 1500C	- D 1500C	40	1500	1.5	750
- U 2000C	- D 2000C	40	2000	1.5	1000

橫貼尺 Horizontal Rulers

0020

名稱 Name	材質 Material
本體 Base metal	鋼鐵 Steel (ST)
刻度 Scale / 公制 Metric	
0020 - L Type A	
零在中邊 The zero of the scale from left side	
0020 - R Type B	
零在右邊 The zero of the scale from right side	
0020 - C Type C	
零在中邊 The zero of the scale from middle	

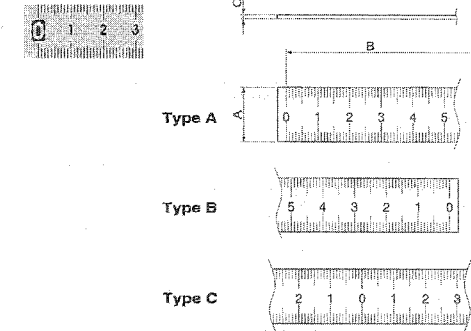

(mm)

Order No. Type A	Order No. Type B	Order No. Type C	A	B	C
0020 - 13 - 1000L	0020 - 13 - 1000R	0020 - 13 - 1000C	13	1000	0.2
- 13 - 1500L	- 13 - 1500R	- 13 - 1500C	13	1500	0.2
- 13 - 2000L	- 13 - 2000R	- 13 - 2000C	13	2000	0.2
- 16 - 1000L	- 16 - 1000R	- 16 - 1000C	16	1000	0.2
- 16 - 1500L	- 16 - 1500R	- 16 - 1500C	16	1500	0.2
- 16 - 2000L	- 16 - 2000R	- 16 - 2000C	16	2000	0.2

直貼尺 Vertical Rulers

0030

名稱 Name	材質 Material
本體 Base metal	鋼鐵 Steel (ST)
刻度 Scale / 公制 Metric	
0030 - U Type A	
零在上邊 The zero of the scale on up	
0030 - D Type B	
零在下邊 The zero of the scale on down	

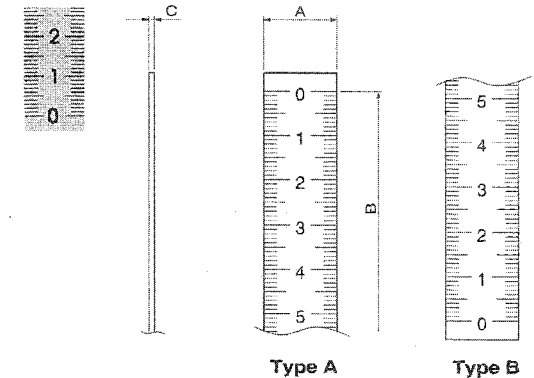

(mm)

Order No. Type A	Order No. Type B	A	B	C
0030 - 1000U	0030 - 1000D	16	1000	0.2
- 1500U	- 1500D	16	1500	0.2
- 2000U	- 2000D	16	2000	0.2

Indexing Bolts

from Steel resp. Stainless Steel

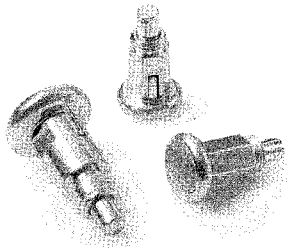

Indexing Bolts have the same application as Fixing Bolts. However they are a low-cost alternative to them.

Model: Head from pressure die-cast zinc, zinc plated. Sleeve and bolt from steel, zinc plated or stainless steel.

Type A: without Fixing Slot
Type B: with Fixing Slot

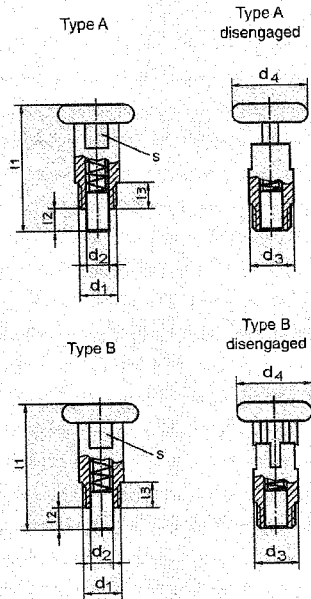

Indexing Bolts - Steel

Order No.	Order No.	Size	d ₁	d ₂	d ₃	l ₁	l ₂	l ₃	Type A	Type B
Type A	Type B	d ₄ mm	d ₁ mm	d ₂ mm	d ₃ mm	l ₁ mm	l ₂ mm	l ₃ mm	s	s
77 06 A	77 06 B	18	M10x1	6	11,4	31	7	4	10	10
77 07 A	77 07 B	24	M12x1,75	7	14,0	40	7	8	12	12

Indexing Bolts - Stainless Steel

Order No.	Order No.	Size	d ₁	d ₂	d ₃	l ₁	l ₂	l ₃	Type A	Type B
Type A	Type B	d ₄ mm	d ₁ mm	d ₂ mm	d ₃ mm	l ₁ mm	l ₂ mm	l ₃ mm	s	s
77 06 A E0A	77 06 B E0A	18	M10x1	6	11,4	31	7	4	10	10
77 07 A E0A	77 07 B E0A	24	M12x1,75	7	14,0	40	7	8	12	12

Flat Tension Levers

adjustable

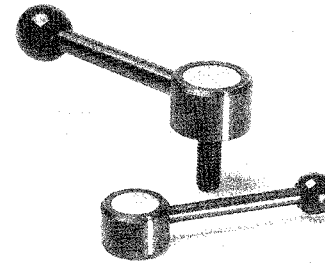

Flat Tension Levers from steel. For clamping needs where the vertical space is extremely restricted. The height of this lever has been kept to a minimum to meet these requirements.

Model: Steel parts stability class 5.8, black oxide finished. Ball knob DIN 319, plastic, black.

Type D: straight handle.
Type E: cranked handle 15°.

Special types such as different thread diameter, screw length are available on request.

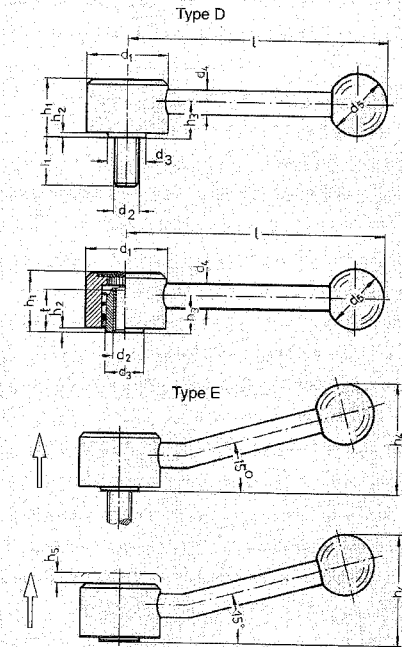

Flat Tension Levers - Internal Thread

Order No.	Order No.	Size	internal Thread	d ₁	d ₃	d ₄	d ₅	h ₁	h ₂	h ₃	h ₄	h ₅	l	t	No. of Teeth	Weight approx. kg
Type D	Type E		d ₂	mm	mm	mm	mm	mm	mm	mm	mm	mm	mm	mm		
15 32 06 999 D		32	M 6	32	13,5	8	20	20,5	1,5	12,5	36	4	100	11	24	0,139
15 32 08 999 D	15 32 08 999 E		M 8													
15 36 08 999 D		36	M 8	36	16	10	25	24,5	2	15	45	4,5	120	14	26	0,219
15 36 10 999 D	15 36 10 999 E		M 10													
15 40 10 999 D		40	M 10	40	19	12	30	26,5	2	16	50	4,5	130	17	28	0,301
15 40 12 999 D	15 40 12 999 E		M 12													
15 45 16 999 D	15 45 16 999 E	45	M 16	45	23	12	32	31,5	2	20	60	5	145	23	30	0,406

Flat Tension Levers - External Thread

Order No.	Order No.	Size	External Thread	Length of Screw l ₁ (mm)												
Type D	Type E		d ₂													
15 32 08 ... D	15 32 08 ... E	32	M 8	16	20	25	32	40	50	63						
15 32 10 ... D	15 32 10 ... E		M 10		20	25	32	40	50	63						
15 36 10 ... D	15 36 10 ... E	36	M 10	20	25	32	40	50	63							
15 36 12 ... D	15 36 12 ... E		M 12		25	32	40	50	63							
15 40 12 ... D	15 40 12 ... E	40	M 12	25	32	40	50	63								
15 45 16 ... D	15 45 16 ... E	45	M 16	32	40	50	63									

... Please indicate here the desired length of screw e.g. 032 for l₁ = 32 mm.

Tension Levers

adjustable

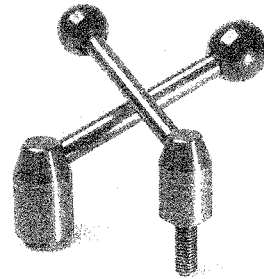
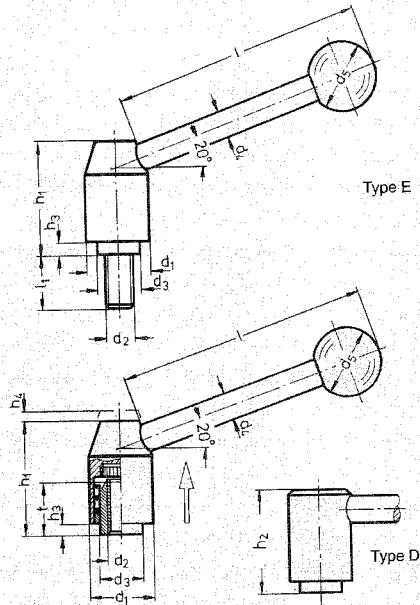

Tension Levers from steel. For applications requiring maximum stability. Tension levers meet the requirements for a strong and comfortable clamping means.

Model: Steel parts stability class 5.8, black oxide finished. Ball knob DIN 319, plastic, black.

Type E: lever position 20°.

Type D: lever position 0°.

Special types such as different thread diameter, screw length, etc. are available on request.

Tension Levers - Internal Thread

Order No.	Order No.	Internal Thread	d ₁	Size	d ₃	d ₄	d ₅	h ₁	h ₂	h ₃	h ₄	l	t	No. of Teeth	Weight approx. kg
Type E	Type D	d ₂	mm		mm	mm	mm	mm	mm	mm	mm	mm	mm		
14 21 06 999 E	14 21 06 999 D	M 6	21	21	13,5	8	20	33,5	31	1	4	70	11	24	0,095
14 21 08 999 E	14 21 08 999 D	M 8	24	24	16	10	25	40	37	2,5	4,5	96	14	26	0,155
14 24 08 999 E	14 24 08 999 D	M 8	24	24	16	10	25	40	37	2,5	4,5	96	14	26	0,155
14 24 10 999 E	14 24 10 999 D	M 10	28	28	19	12	30	48,5	44,5	4,5	4,5	110	17	28	0,261
14 28 10 999 E	14 28 10 999 D	M 10	28	28	19	12	30	48,5	44,5	4,5	4,5	110	17	28	0,261
14 28 12 999 E	14 28 12 999 D	M 12	33	33	23	12	32	55	51,5	6	5,5	124	23	30	0,372
14 33 12 999 E	14 33 12 999 D	M 12	33	33	23	12	32	55	51,5	6	5,5	124	23	30	0,372
14 33 16 999 E	14 33 16 999 D	M 16	40	40	28	14	35	68	64	6	5,5	138	36	50	0,615
14 40 20 999 E	14 40 20 999 D	M 20	40	40	28	14	35	68	64	6	5,5	138	36	50	0,615

Tension Levers - External Thread

Order No.	Order No.	Size	External Thread	Length of Screw l ₁ (mm)							
Type E	Type D		d ₂	21	24	28	33	40	50	63	
14 21 08 ... E	14 21 08 ... D	21	M 8	16	20	25	32	40	50	63	
14 24 10 ... E	14 24 10 ... D	24	M 10	16	20	25	32	40	50	63	
14 28 10 ... E	14 28 10 ... D	28	M 10	20	25	32	40	50	63	63	
14 28 12 ... E	14 28 12 ... D	28	M 12	20	25	32	40	50	63	63	
14 33 12 ... E	14 33 12 ... D	33	M 12	25	32	40	50	63	63	63	
14 33 16 ... E	14 33 16 ... D	33	M 16	32	40	50	63	63	63	63	
14 40 20 ... E	14 40 20 ... D	40	M 20	40	50	63	63	63	63	63	

... Please indicate here the desired length of screw e.g. 032 for l₁ = 32 mm.

Grips

from Steel resp. Stainless Steel



Grips are simple operating elements suitable for various types of applications.

Model: Handle from steel, black oxide finish, resp. stainless steel 1.4305, matt. Plastic knobs Duroplastic FS 31, black polished.

Type A: with ball knob DIN 319

Type C: with taper knob

Type E: with cylindrical knob

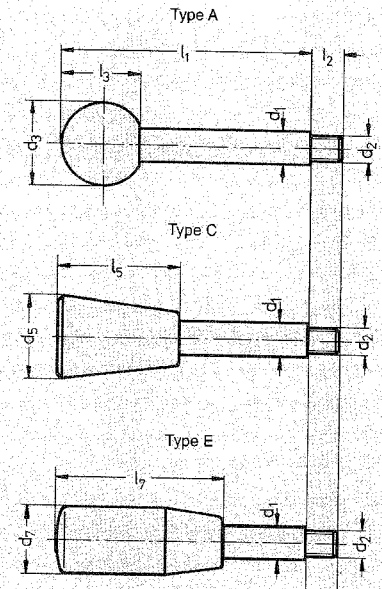

Grips - Steel

Order No.	Order No.	Order No.	Size	Thread	Length of Screw l ₁ (mm)		l ₂
Type A	Type C	Type E	d ₁	d ₂	100	125	mm
35 08 ... A	35 08 ... C	35 08 ... E	18	8	63	100	9
35 10 ... A	35 10 ... C	35 10 ... E	21	10	80	125	11
35 12 ... A	35 12 ... C	35 12 ... E	23	12	100	160	14
35 14 ... A	35 14 ... C	35 14 ... E	26	14	125	200	16

... Please indicate here the desired length e.g. 100 for l₁ = 100 mm.

Grips - Stainless Steel

Order No.	Order No.	Size	Thread	Length of Screw l ₁ (mm)		l ₂
Type A	Type E	d ₁	d ₂	80	125	mm
35 08 ... A E0A	35 08 ... E E0A	18	8	63	100	9
35 10 ... A E0A	35 10 ... E E0A	21	10	80	125	11
35 12 ... A E0A	35 12 ... E E0A	23	12	100	160	14
35 14 ... A E0A	35 14 ... E E0A	26	14	125	200	16

... Please indicate here the desired length e.g. 080 for l₁ = 80 mm.

Quick Acting Star Knobs

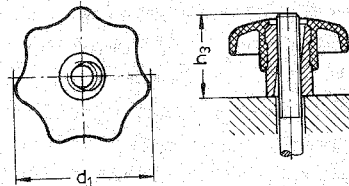
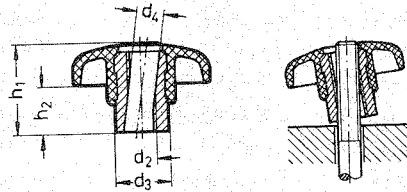
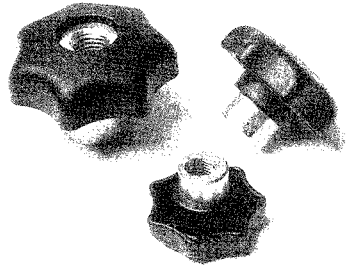

Quick acting star knobs are used in such applications where the knob has to be completely removed after the releasing operation and refitted very rapidly for re-clamping. The knob is tilted over the threaded spindle. When in position, the knob is brought into a straight position for meshing of the two threads on nut and spindle. The knob will then have to be turned only by fraction of a rotation to achieve clamping. The use of this knob is, however, limited to such applications where relatively low clamping forces are required.

Model: Body from reinforced polyamide, black matt. Bush from steel, zinc-plated.

Quick Acting Star Knobs

Order No.	Internal Thread d ₂	Size d ₁ mm	d ₄ mm	d ₅ mm	h ₁ mm	h ₂ mm	h ₃ min. mm	Weight approx. g
25 40 08	M 8	40	8,4	16	26	13	24	31
25 50 10	M 10	50	10,5	20	34	17	30	61
25 63 12	M 12	63	13	26	42	21	37	130

Cross Knobs

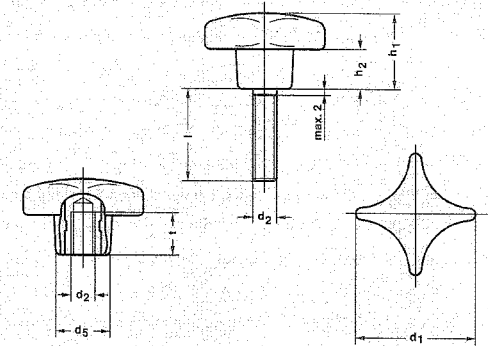
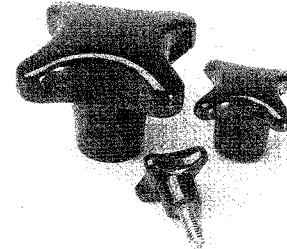

Model: Body from duroplastic FS 31. Bush resp. screw from steel, zinc-plated.

Cross knobs from cast iron or aluminium are available on request.

Cross Knobs similar to DIN 6335

Order No.	Internal Thread d ₂	t mm	Weight approx. kg	Order No.	External Thread d ₂	Length of Screw l (mm)	Size d ₁ mm	d ₅ mm	h ₁ mm	h ₂ mm
21 25 05	M 5	10,5	0,006	21 25 05 ...	M 5	10	25	11	17	9
21 32 06	M 6	13,5	0,010	21 32 06 ...	M 6	15 20 30	32	14	20	10
21 40 08	M 8	16	0,018	21 40 08 ...	M 8	15 20 30	40	18	26	15
21 50 10	M 10	21	0,033	21 50 10 ...	M 10	20 30 40	50	22	23	20
21 63 12	M 12	25	0,061	21 63 12 ...	M 12	25 30 40 63	63	27	40	23

... Please indicate here the desired length of screw e.g. 020 for l = 20 mm.

Cross Knobs

with Projecting Steel Bush

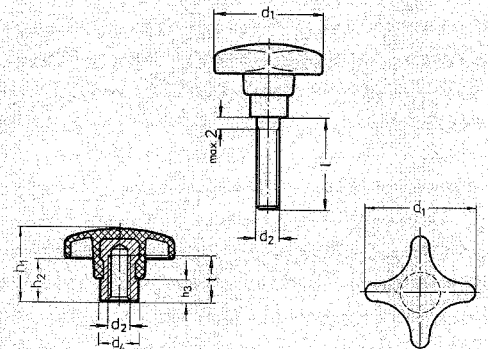
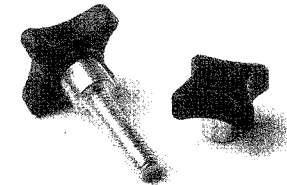

Cross Knobs with projecting steel bush. Especially suitable for cross pin connections.

Model: Body from polyamide, black matt. Bush resp. screw from steel, zinc-plated.

Cross Knobs with fitting hole H7 are available on request.

Cross Knobs with Projecting Steel Bush

Order No.	Internal Thread d ₂	t mm	Order No.	External Thread d ₂	Length of Screw l (mm)	Size d ₁ mm	d ₄ mm	h ₁ mm	h ₂ mm	h ₃ mm
23 32 06	M 6	12	23 32 06 ...	M 6	16 20 30	32	12	20	10	9
23 40 08	M 8	14	23 40 08 ...	M 8	16 25 30	40	14	25	13	10
23 50 10	M 10	18	23 50 10 ...	M 10	25 35 55	50	18	32	20	12
23 63 12	M 12	22	23 63 12 ...	M 12	30 40 60 63	63	20	40	25	14

... Please indicate here the desired length of screw e.g. 020 for l = 20 mm.

Fixing Bolts

from Steel resp. Stainless Steel

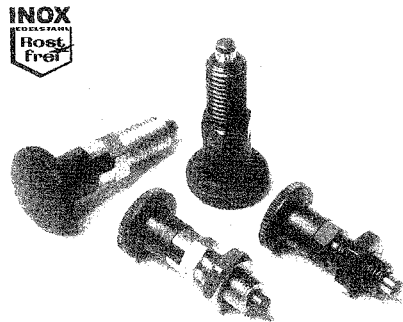
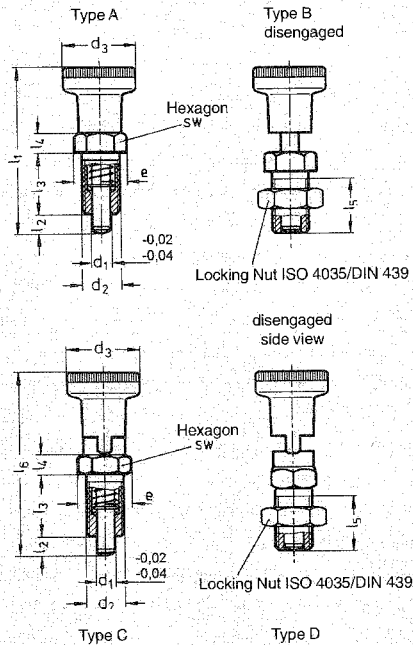

Model Steel: Knob from polyamide black matt. Steel parts stability class 5.8, black oxide finish. Locking bolt hardened and ground.

Model Stainless Steel: Knob from polyamide black matt. Steel parts from stainless steel, Material No. 1.4305. Locking bolt ground and nitrated.

Type A: without Fixing Slot, without Locking Nut
Type B: without Fixing Slot, with Locking Nut
Type C: with Fixing Slot, without Locking Nut
Type D: with Fixing Slot, with Locking Nut

Note for Fixing Bolts:

Fixing bolts are used when a change of resting position by axial loads has to be avoided. Another resting position only can be choiced if bolt has been pressed out manually. If fixing pin has to be locked out longer time and unintentional resting has to be avoided, please use Type C resp. Type D.

Fixing Bolts - Steel

Order No.	Order No.	Order No.	Order No.	Size	d ₁	d ₂	d ₃	e	l ₁	l ₂ min.	l ₃	l ₄	l ₅	l ₆ min.	sw
Type A	Type B	Type C	Type D		mm	mm	mm	mm	mm	mm	mm	mm	mm	mm	
30 05 A	30 05 B	30 05 C	30 05 D	5	M 10 x 1	21	13,8	45	5	17	5	15	51	12	
30 06 A	30 06 B	30 06 C	30 06 D	6	M 12 x 1,5	25	16,2	54,5	6	20	6	17	61	14	
30 08 A	30 08 B	30 08 C	30 08 D	8	M 16 x 1,5	31	21,9	69	8	26	8	23	75,5	19	
30 10 A	30 10 B	30 10 C	30 10 D	10	M 20 x 1,5	31	25,4	80	10	33	10	30	91	22	

Fixing Bolts - Stainless Steel

Order No.	Order No.	Order No.	Order No.	Size	d ₁	d ₂	d ₃	e	l ₁	l ₂ min.	l ₃	l ₄	l ₅	l ₆ min.	sw
Type A	Type B	Type C	Type D		mm	mm	mm	mm	mm	mm	mm	mm	mm	mm	
30 05 A E0A	30 05 B E0A	30 05 C E0A	30 05 D E0A	5	M 10 x 1	21	13,8	45	5	17	5	15	51	12	
30 06 A E0A	30 06 B E0A	30 06 C E0A	30 06 D E0A	6	M 12 x 1,5	25	16,2	54,5	6	20	6	17	61	14	
30 08 A E0A	30 08 B E0A	30 08 C E0A	30 08 D E0A	8	M 16 x 1,5	31	21,9	69	8	26	8	23	75,5	19	
30 10 A E0A	30 10 B E0A			10	M 20 x 1,5	31	25,4	80	10	33	10	30		22	

Fixing Bolts

without Collar
Steel / Stainless Steel



Fixing bolts without collar are a low cost alternative.

Model Steel: Knob from polyamide black matt. Steel parts stability class 5.8, black oxide finished. Locking bolt hardened and ground.

Model Stainless Steel: Steel parts from stainless steel, material no. 1.4305. Locking bolt ground and nitrated.

A special screwdriver is available. Two slots are provided in the upper end of the body which are accessible with the knob in its retracted position.

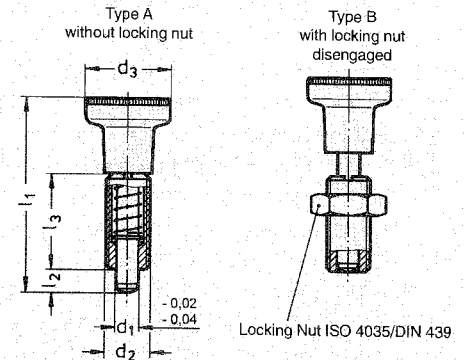

Fixing Bolts without Collar - Steel resp. Stainless Steel

Order No. Steel Type A	Order No. Steel Type B	Order No. Stainless Steel Type A	Order No. Stainless Steel Type B	Größe	d ₁ mm	d ₂ mm	d ₃ mm	l ₁ mm	l ₂ min. mm	l ₃ mm	Order No. Screw Driver
59 05 A	59 05 B	59 05 A E0A	59 05 B E0A	5	M 10 x 1	21	44	5	22	59 05 S	
59 06 A	59 06 B	59 06 A E0A	59 06 B E0A	6	M 12 x 1,5	25	53	6	26	59 06 S	
59 08 A	59 08 B	59 08 A E0A	59 08 B E0A	8	M 16 x 1,5	31	67	8	34	59 08 S	
59 10 A	59 10 B	59 10 A E0A	59 10 B E0A	10	M 20 x 1,5	31	78	10	43	59 10 S	

Fixing Bolts

without Thread

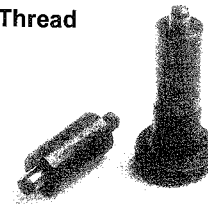

Fixing bolts without thread are for applications where welding or resin bonding is favoured. Type G with threaded bolt end are for applications where a special knob to customers own design is required or for such cases where the spindle is linked directly to an operating mechanism.

Model: Knob from polyamide black matt. Steel parts black oxide finished, weldable. Locking bolt hardened and ground.

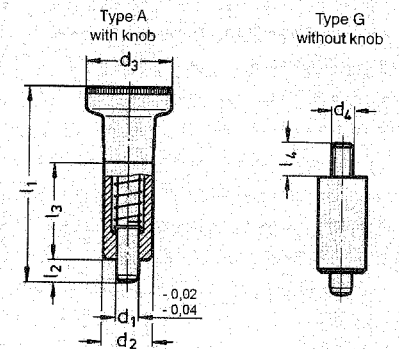

Fixing Bolts without Thread

Order No. Type A	Order No. Type G	Size	d ₁ mm	d ₂ mm	d ₃ mm	d ₄ mm	l ₁ mm	l ₂ min. mm	l ₃ mm	l ₄ mm
58 05 A	58 05 G	5	12	21	M 5	44	5	22	6	
58 06 A	58 06 G	6	14	25	M 6	53	6	26	10	
58 08 A	58 08 G	8	18	31	M 8	67	8	34	12	

Offset Crank Handles

DIN 468

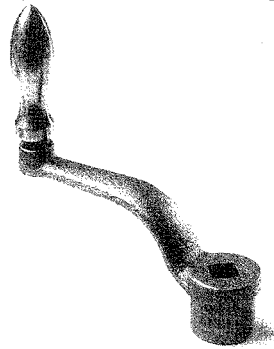
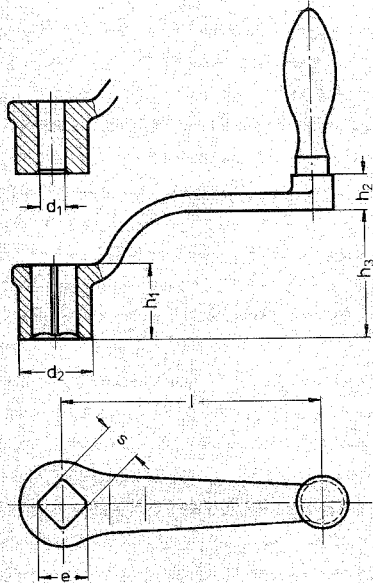

Crank Handles DIN 468 are available as standard with steel grips. Grip from plastic (only Type B) can be supplied on request.

Model:

Crank body cast iron (GGG);
Hub machined, cast edge deburred and sand-blasted.

Type A: with fixed grip.
Type B: with revolving grip.

Plastic crank handles are available on request.

Offset Crank Handles DIN 468

Order No. Type A with Square Hole S H ₁₁	Order No. Type A with Fitting Hole d ₁ H ₇	Order No. Type B with Square Hole S H ₁₁	Order No. Type B with Fitting Hole d ₁ H ₇	Square Hole S H ₁₁	e mm	Fitting Hole d ₁ H ₇	l mm	d ₂ mm	h ₁ mm	h ₂ mm	h ₃ mm	∅ Ball Grip
65 080 10 VKT A	65 080 08 PBG A	65 080 10 VKT B	65 080 08 PBG B	V 10	13,1	8	80	24	24	13	38	18
65 100 12 VKT A	65 100 10 PBG A	65 100 12 VKT B	65 100 10 PBG B	V 12	16,1	10	100	28	28	13	48	20
65 125 14 VKT A	65 125 10 PBG A	65 125 14 VKT B	65 125 10 PBG B	V 14	18,1	10	125	34	34	14	55	22
65 160 17 VKT A	65 160 14 PBG A	65 160 17 VKT B	65 160 14 PBG B	V 17	22,2	14	160	38	38	14	65	25
65 200 19 VKT A	65 200 17 PBG A	65 200 19 VKT B	65 200 17 PBG B	V 19	25,2	17	200	44	44	21	78	28
65 250 22 VKT A	65 250 17 PBG A	65 250 22 VKT B	65 250 17 PBG B	V 22	28,2	17	250	48	48	21	90	32

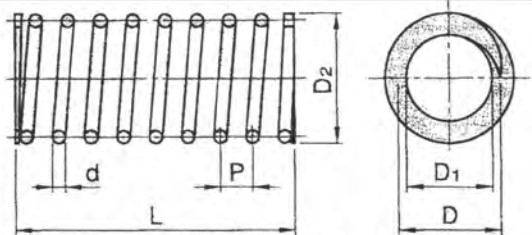

COMPRESSION SPRING

WIRE SIZE FROM 0.15mm TO 50mm

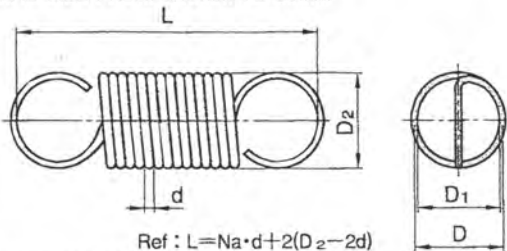

Ref : $L = Na \cdot d + 2(D_2 - 2d)$

EXTENSION SPRING

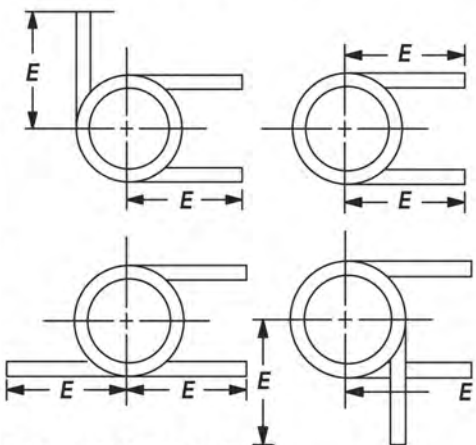

TORSION SPRING

ANY QUANTITY ABOVE 10 PCS

A GUIDED MAP TO OUR SHOP:



OUR LOCATION

- GOOD HAND TOGGLE CLAMPS
- SPRING
- MAGNET
- SHIM FOIL (0.005 - 2MM)
- PLASTIC SHIM
- HARDWARE
- HANDLING PARTS